

Always check the website for the most updated specifications: [www.americh.com](http://www.americh.com)

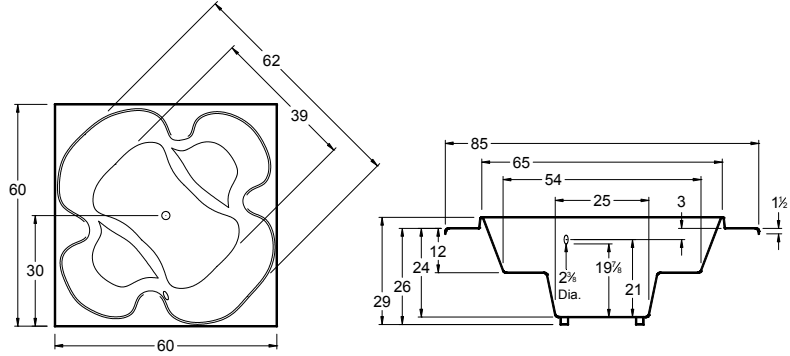

Tub pictured with optional waste & overflow



All bathtub dimensions are ± 1/2"

## Builder Series

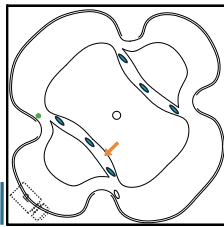

## Luxury Series

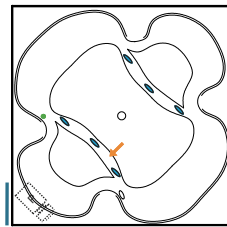

## Platinum Series

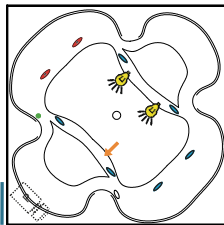

## Combination

(pump and blower location only)

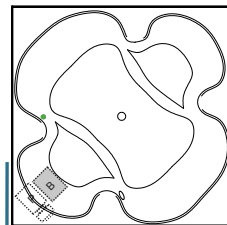

## Airbath System II

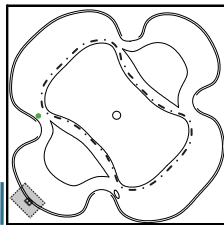

## Airbath System III

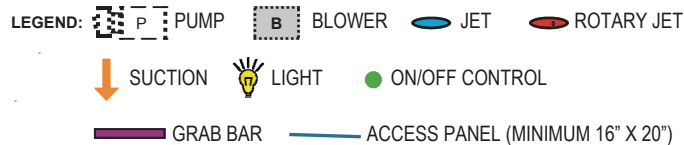
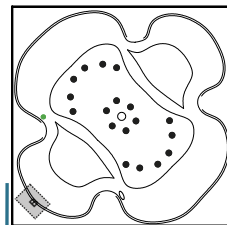

### INSTALLATION TIPS

- Install according to Owner's Manual and local codes.
- Airbath III units may be 1½" - 2½" higher than stated.
- Any whirlpool or Airbath unit requires an access panel.
- Hot water supply should be 65-75% of tub capacity or greater.
- Always consult your local plumber for recommendations as installations will vary.
- Cut-out dimensions: 58" x 58"

### DIMENSIONS

60" x 60" x 29" (1524 x 1524 x 737 mm)  
 Whirlpool Operating Gallons = 50 (Liters = 189)  
 Gallon to Overflow = 65 (Liters = 246)

**MATERIAL:** Acrylic (All Americh Standard Colors)

**TUB FLOOR:** Textured

**UNDERMOUNT:** No

### ELECTRICAL REQUIREMENTS

Americh recommends one 20 amp ground fault circuit interrupter (GFCI) for each power supply provided with the bathtub.

### OPTIONAL ACCESSORIES

- Chromatherapy\*
- High Density Insulation\*
- iBath Sound System
- Inline Heater (whirlpool only)
- Jets: Additional or Rotary\*
- Ozone System (whirlpool and/or Airbath only)
- Pillow: 17"
- Remote Control Upgrade (select series only)
- Serenity Soak (tub only)
- Syllent Pump with Heated Air\*
- Trim Kit Upgrade\*
- Waste & Overflow
  - Cable Drive Overflow\*

\*Standard on Platinum Series

### CODES AND COMPLIANCE

Americh products meet or exceed the following standards:

- Underwriters Laboratories (UL)
- Underwriters Laboratories - Canada (cUL)
- Canadian Standards Association - (CSA)
- ANSI Z124.1 • ANSI A112-19.7
- ANSI A112.19.8 • ASTM F462-79

Contact Americh for additional approvals.