

# CRYSTORAMA

1958

95 Cantiague Rock Road, Westbury, NY 11590 • toll free: 1.800.888.4470 fax: 516.931.1254 • info@crystorama.com • www.crystorama.com

MODEL #: 297-PN

## ASSEMBLY AND DRESSING INSTRUCTIONS



**WARNING:** This product can expose you to Lead which is known to the state of California to cause cancer and/or birth defects or reproductive harm. For more information go to [www.P65Warnings.ca.gov](http://www.P65Warnings.ca.gov)

All electrical components must be installed by a licensed electrician in accordance with the National Electric Code and the appropriate local electrical codes.

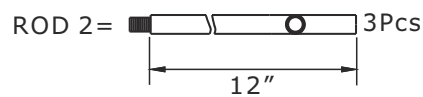
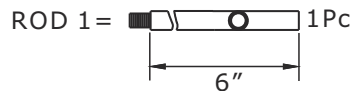
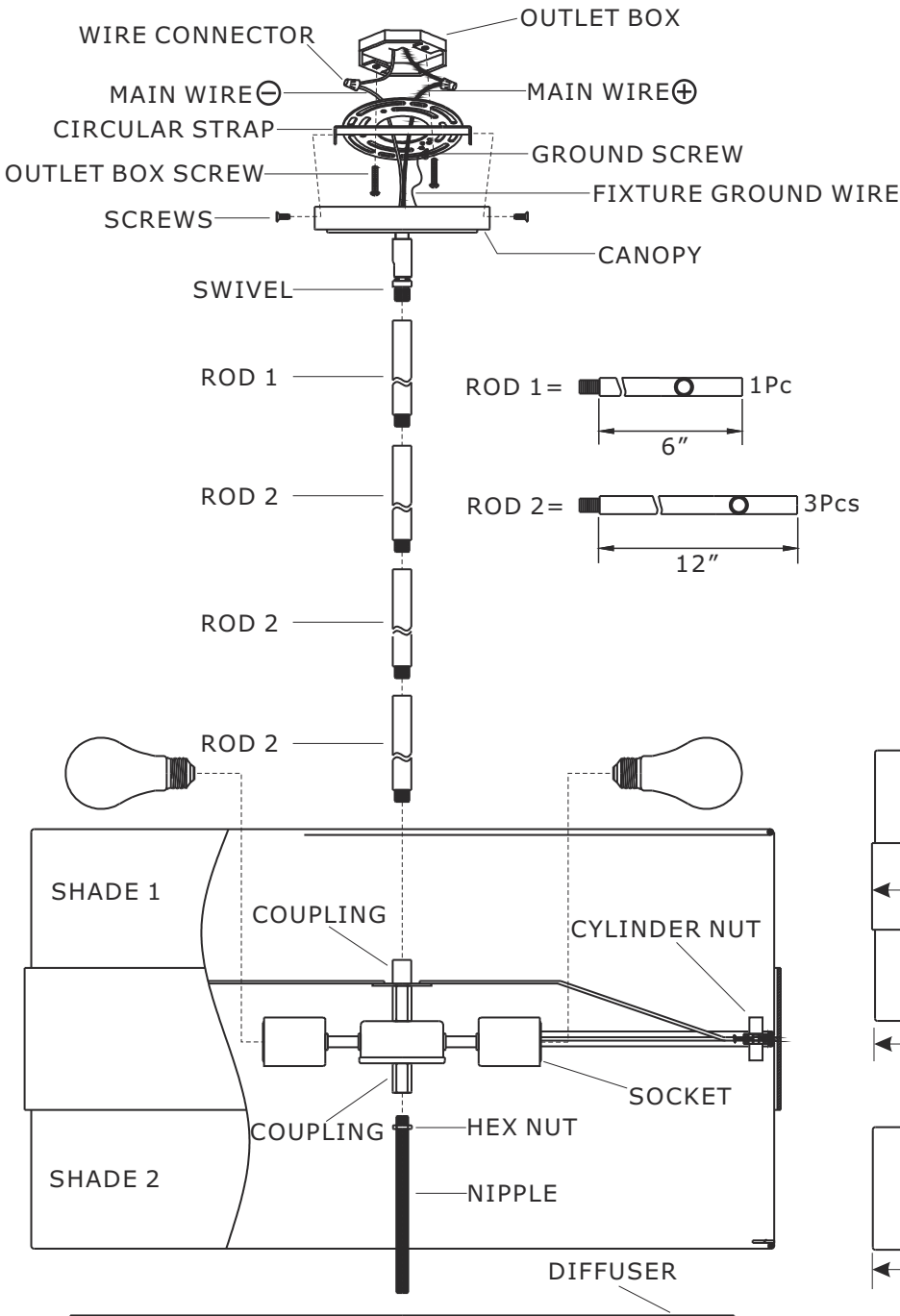

 You will need 5 **Frosted** Medium A19 bulbs. 60 Watts recommended 100 Watts max. Bulb not included. **USE LED BULBS FOR EXTENDED USE**

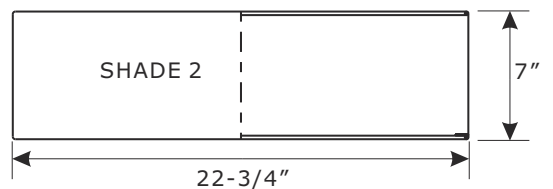
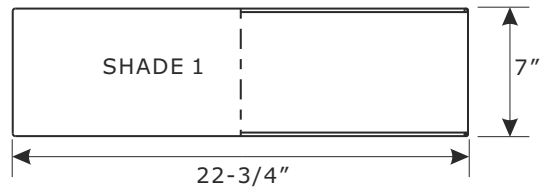
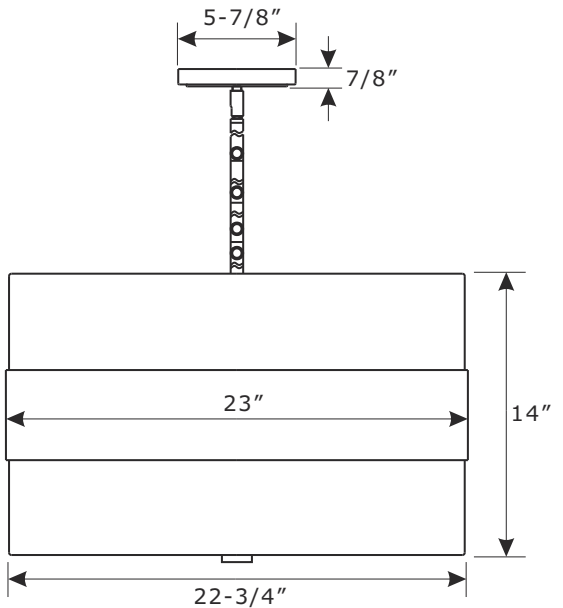

-  PLASTIC WASHER
-  FINIAL

### HOW TO REPLACE BULB:

FROM THE TOP OPENING OF SHADE, REPLACE PREVIOUS BULB W/ NEW BULB.

(IF REPLACED FROM THE BOTTOM, YOU NEED TO REMOVE THE BOTTOM FINIAL AND DIFFUSER TO REPLACE THE BULB.)

2018-08