

Trade Mark:  
CRYSTAL WORLD INC

Product Name: Pendant lamp  
Model :5555P17SN-R  
120Vac, 60Hz,AC ONLY  
Lamp Size:D17"\*H8"~H65"

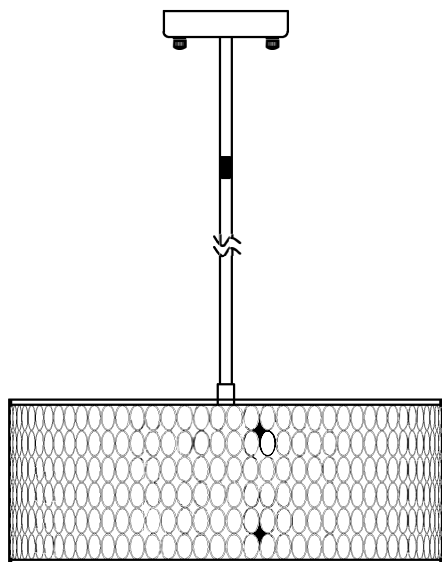

## PENDANT LAMP ASSEMBLY INSTRUCTIONS

1. Place fixture(A) onto mounting screws (DD). secure with cap nuts (AA).

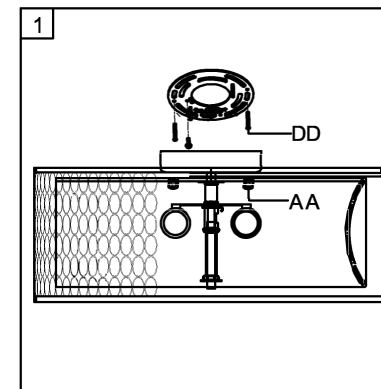

### Hardware Used

AA Cap nut  X 2

DD Mounting screw  X 2

2. lighting bulbs ( not included).

USE 120V E26  3\*60W Max.

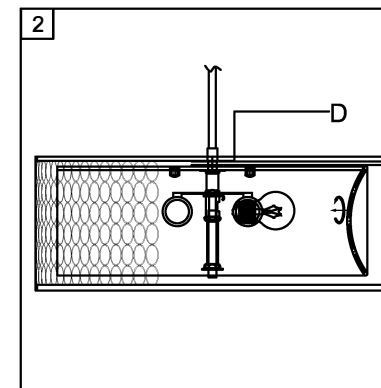

3. Please fix part(B) with part(A).

