

LIVING DISTRICT

Collection: TAYE

Installation manual for:









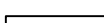

LD5012F18 D18"H8"L4

Installation instructions:

1. Black wire from ceiling(junction box) attaches to "L" wire from the fixture.
2. White wire from ceiling(junction box) attaches to "N" wire from the fixture.
3. "E" wire from the fixture is attached to the mounting bracket and an additional "E" wire from the mounting bracket must be secured to the junction box.
4. Secure mounting bracket to the junction box.
5. Insert screws (P2) in side of top unit the mounting bracket.
6. Use the finial (P7) to fix the canopy(P4) into the mounting bracket(P1).
7. Install the bulbs(not included) into the lamp fixture.
8. Fix the metal lampshade(P10) into the tube (P9), and cover the metal plate(P11), then fasten by the finial (P12).

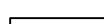
The end!

PARTS LIST

part	picture	Description	Qty	Check list
P1		L12. 6" Mounting bracket	1	
P2		5/32-32 Screw	2	
P3		Power Cord 10" 18#	1	
P4		ø18"H1" canopy plat	1	
P5		D1. 2"H2" metal lampcap	4	
P6		E12 lampholder	4	
P7		finial	4	
P8		lamparm	4	
P9		D0. 45" iron tube	1	
P10		D18"H6. 5" metal lampshade	1	
P11		metal plate	1	
P12		finial	1	

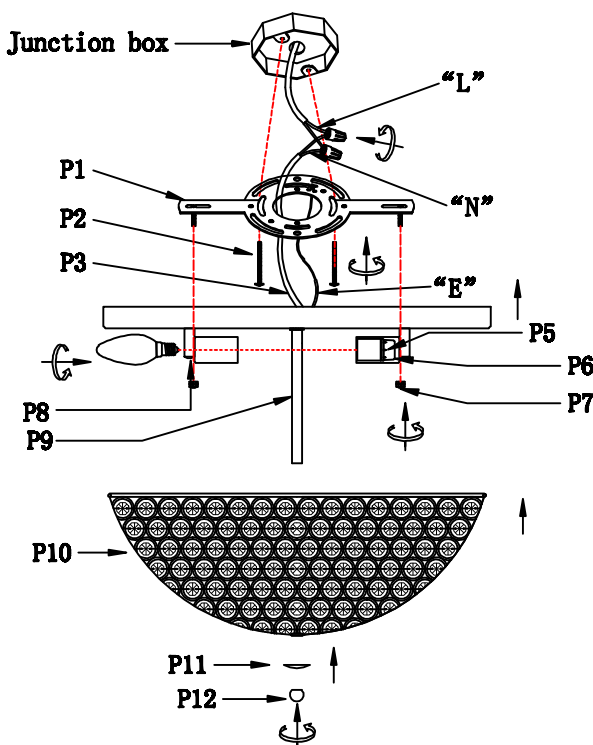

"L" = Hot wire
 "N" = Neutral wire
 "E" = Ground wire