

# LIVING DISTRICT

Collection:ROHAN

Installation manual for

LD5056D48 D48"H25"L6

## Installation instructions:

1. Install the metal tube (P9) on the lamp body (P12)
2. Black wire from ceiling (junction box) attaches to "L" wire from the fixture.
3. White wire from ceiling (junction box) attaches to "N" wire from the fixture.
4. "E" wire from the fixture is attached to the mounting bracket and an additional "E" wire from the mounting bracket must be secured to the junction box.
5. Secure mounting bracket to the junction box.
6. Insert screws (P2) in side of top unit the mounting bracket.
7. Fix the loop (P3) to screw tube, then cover the canopy (P4) and fix it by canopy ring (P5).
8. Install the bulbs (not included) into the lamp fixture

The end!

## PARTS LIST

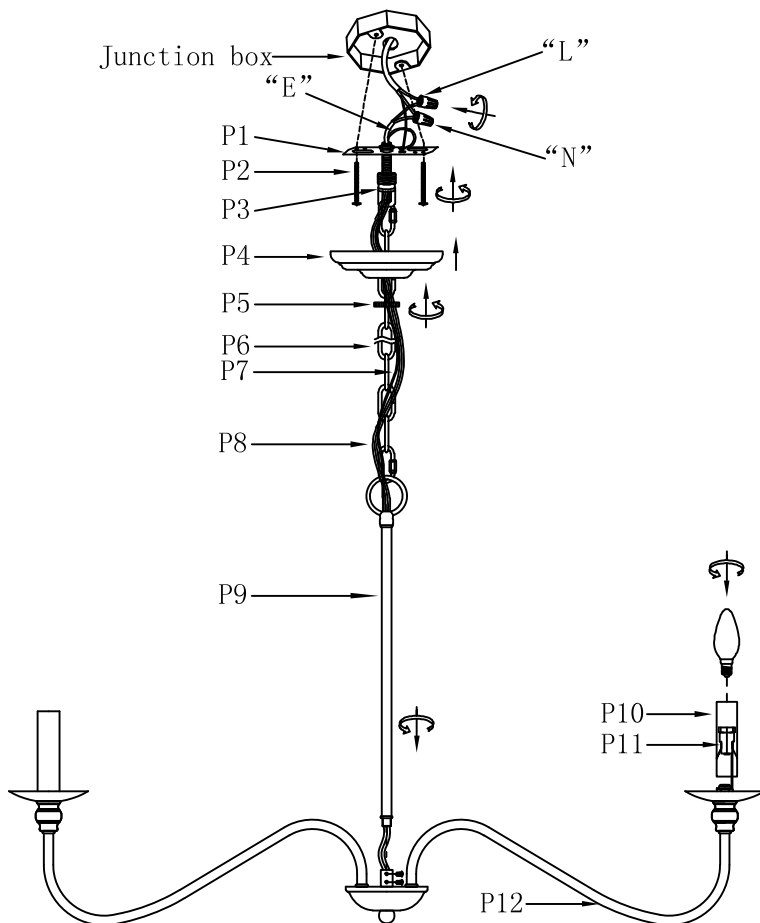

part	picture	Description	Qty	Check list
P1		L4" Mounting bracket	1	
P2		8/32-32 Screw	2	
P3		Canopy loop (Canopy part)	1	
P4		ø5.2" canopy plate	1	
P5		Canopy ring (Canopy part)	1	
P6		L59" CHAIN 04PBK/BR/PN Plain Design	1	
P7		Ground wire	1	
P8		Power Cord 79" SPT-1-18#	1	
P9		L21.0" tube	1	
P10		D1"*3.5" tube	6	
P11		E12 lampholder	6	
P12		D48"*H10.4" lampbody	1	

"L" = Hot wire

"N" = Neutral wire

"E" = Ground wire