

Front view

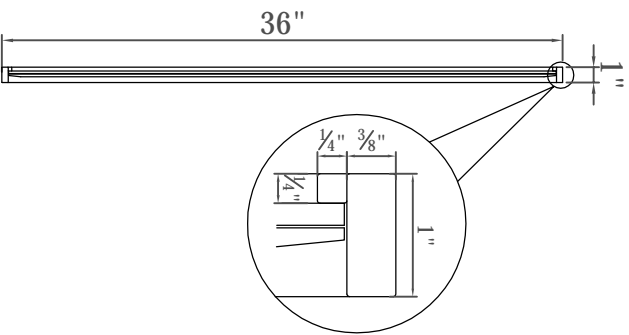

Side view

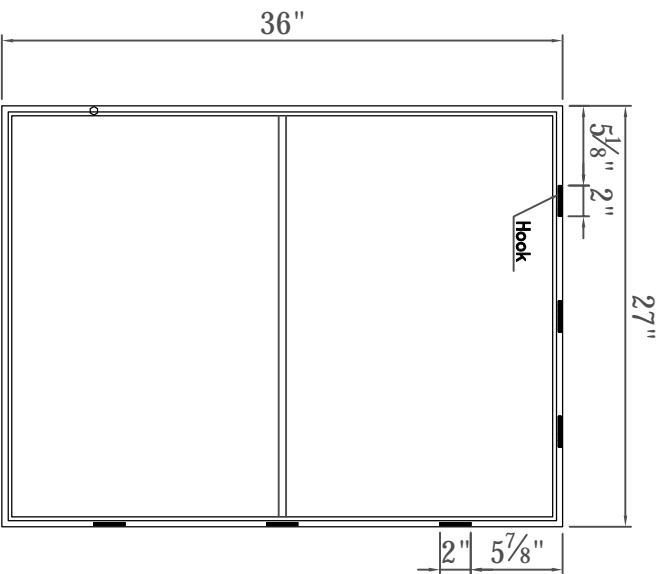

Back view

DWG. NO.

MODEL NO:
MR42736BK

SPEC NO:

QUANTITY:

DATE:

CHECKED BY:

FOR PROPOSAL ONLY ALL
DIMENSIONS TO BE VERIFIED

PROJECT:

COLOR:

FINISH:

REVISIONS

1	
2	
3	
4	
5	
6	

 **ELEGANT**
FURNITURE & LIGHTING™

500-550 E. Erie Avenue

Philadelphia PA 19134

1-888-388-3390

Model #	Product Type	Style	Product Width (in)	Product Depth (in)	Product Height (in)	Mirror Width	Mirror Depth
MR42736BK	Mirror	Contemporary	27	1	36	26.25"	0.16"
Mirror Height	Frame shape	Orientation	Frame finish	Frame material	Mounting / attachment type	Number of brackets	Beveled glass
35.25"	Rectangle	Vertical and Horizontal	Black	Metal and MDF	Metal Inset hanger	6	Yes
Frames	Package LENGTH	Package WIDTH	Package HEIGHT	Package Weight	Product weight	Shipment Type	
No	31.75	41.25	4.5	36.08	14.08	Small Parcel	

DWG. NO.

MODEL NO:

MR42736BK

SPEC NO:

QUANTITY:

DATE:

CHECKED BY:

FOR PROPOSAL ONLY ALL DIMENSIONS TO BE VERIFIED

PROJECT:

COLOR:

FINISH:

REVISIONS

1	
2	
3	
4	
5	
6	



500-550 E. Erie Avenue
Philadelphia PA 19134
1-888-388-3390