

MODEL NO:
VF44024WB
VF44024CG
VF44024WH

ELEGANT
FURNITURE & LIGHTING™

500-550 E. Erie Avenue
Philadelphia PA 19134
1-888-388-3390

PROJECT:

SPEC NO:

MODEL NO:VF44024

QUANTITY:

DRAWING APPROVAL STATUS

- APPROVED
- APPROVED AS NOTED
- NOT APPROVED, REVISE AS NOTED

AUTHORIZED SIGNATURE

DATE:

FOR PROPOSAL ONLY. ALL DIMENSIONS TO BE VERIFIED

Drawing Date:2019-5-7

REVISIONS

△1	
△2	
△3	
△4	
△5	

DWG. NO.

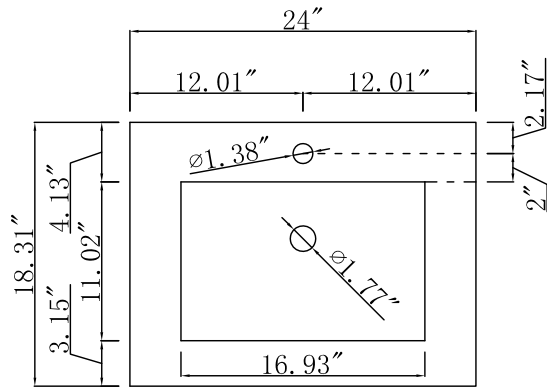

Top view



Length:7"

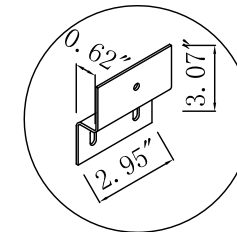

Metal bracket

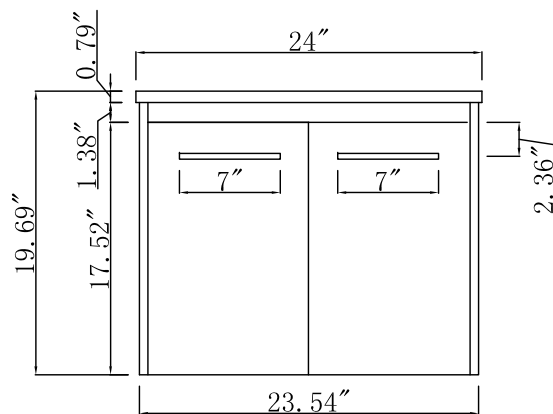

Front view

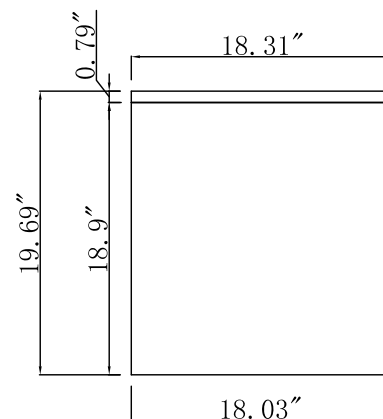

Side view

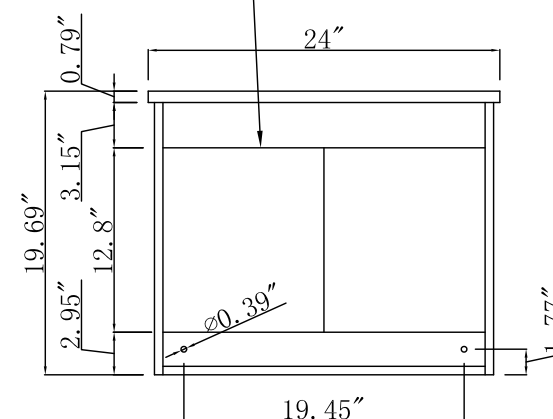

Back view

Model #	VF44024WB	"Number of Doors "	2	"Table: seating capacity"	1	"drawer glide extension"	N/A	"cabinet interior width"	22.36"
Finish	Walnut Brown	"Finished Back "	NO	"upholstery color"	N/A	"drawer glide material"	N/A	"cabinet interior depth"	16.85"
"Hand Painted"	NO	"Hardware finish "	Alumina	"upholstery pattern"	N/A	"drawer dividers"	N/A	"leg height"	N/A
"Mirror type"	N/A	"Assembly "	YES	"cushion material"	N/A	"Drawer Interior finish"	N/A	"leg width"	N/A
"Beveled glass"	N/A	"Product Width "	24"	"base finish"	Walnut Brown	"Ball Bearing Glides"	N/A	"leg depth"	N/A
"Frame material "	MDF	"Product Depth"	18.31"	"powder coated finish"	N/A	"soft close drawer glides"	N/A	"gloss finish"	NO
"Solid wood construction "	N/A	"Product Height"	19.69"	"base material"	MDF	"Number of cabinets"	1	"stackable"	NO
"Drawers Included "	NO	"Package LENGTH"	28.3"	"top material"	Porcelain	"shelf height"	N/A	"leg design"	N/A
"Number of Drawers"	N/A	"Packaged WIDTH"	25.6"	"wood species"	MDF	"shelf width"	N/A	"Armoires: ring slots"	N/A
"Joinery Type "	N/A	"Packaged HEIGHT"	25.2"	"tip over restraint strap "	N/A	"shelf depth"	N/A	"Armoires: hooks"	N/A
"Drawer railing "	N/A	"Package Weight(lbs) "	60	"shape of top"	Rectangle	"Shelf thickness"	N/A	"armoires: mirror dimensions "	N/A
"Drawer Width"	N/A	"Product Weight(lbs)"	51	"lift top"	NO	"Any certification?" (CARB/TSCA VI)	YES	"door thickness"	0.59"
"Drawer Depth "	N/A	"Shipping Type"	Small Parcel	"shelf material"	N/A	"California Proposition 65 warning required"	YES	"false drawers?"	N/A
"Drawer Height "	N/A	"table top width"	18.31"	"adjustable shelves"	NO	"Drawers Interior Height"	N/A	"sink type "	Porcelain
"Shelves "	N/A	"table top finish"	White	"Drawer Handle designs"	Bar Pulls	"Drawer Interior Width"	N/A	"# of faucet holes "	1
"Number of Shelves "	N/A	"glass top tempered"	NO	"saftey stop"	YES	"Drawer Interior Depth"	N/A		
"Doors included "	YES	"table top maximum weight "	66 LBS	"felt lined drawers"	N/A	"cabinet interior height"	18.31"		

DWG. NO.:

MODEL NO.:

ALTERATIONS

1

2

3

4

FOR PROPOSAL ONLY ALL
DIMENSIONS TO BE VERIFIED

SCALE:

DWG. BY:

CHECKED BY:

DATE:

PROJECT:

Qty:

Color:

DRAWING TITLE:

FINISH:

