

ITEM NUMBER: E31258

DESCRIPTION: IQ 24" LED PENDANT

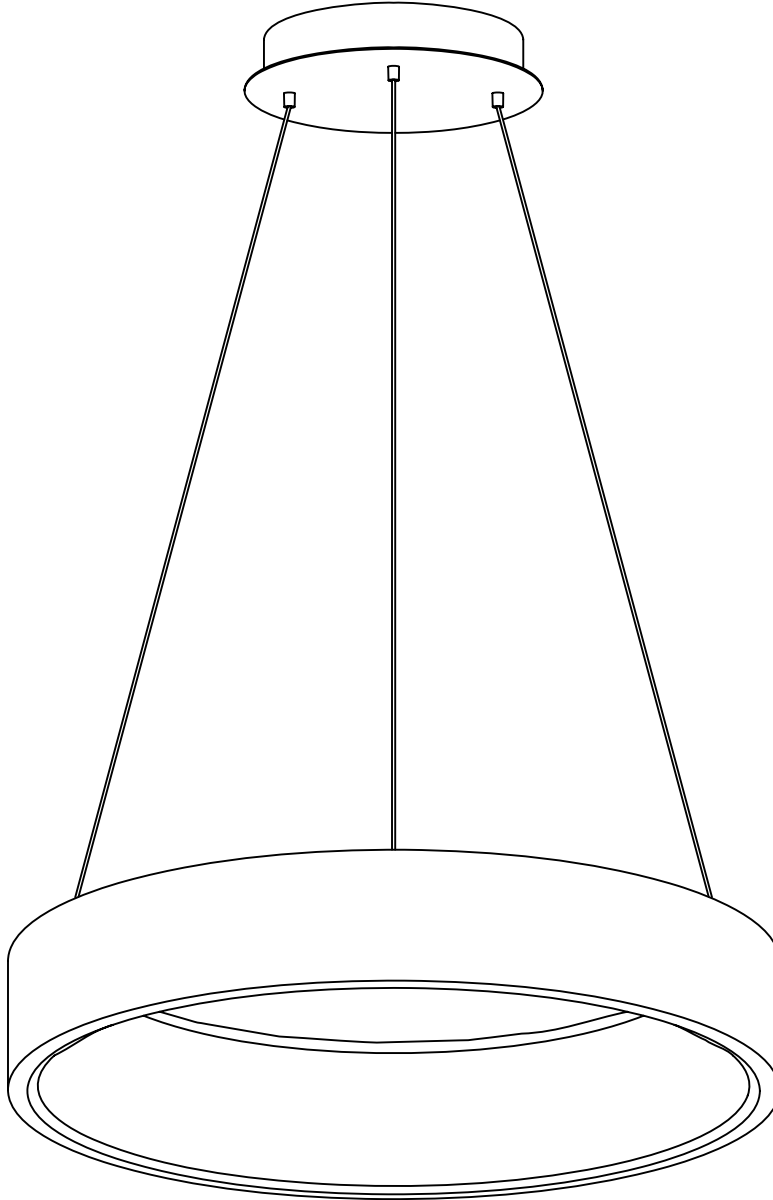

PLEASE CONSULT AN ELECTRICIAN BEFORE INSTALLATION

LAMPING: CCT RGB LED INTEGRATED 40W

Vinput:120-277V

MADE IN CHINA / HECHO EN CHINA / FABRIQUE EN CHINE

LED Lighting (DC Power)

Before Getting Started	Antes de comenzar	Avant de commencer
Read the instructions carefully prior to assembling the product.	Lire attentivement les instructions avant d'assembler le produit.	Lea atentamente las instrucciones antes de ensamblar el producto.
When you open the package with a sharp tool like a cutter knife, be careful not to damage the components inside.	Lorsque vous ouvrez le paquet avec un outil pointu comme un couteau de coupe, veillez à ne pas endommager les composants à l'intérieur.	Cuando abra el paquete con una herramienta afilada como un cuchillo de corte, tenga cuidado de no dañar los componentes dentro.
Carefully remove all packaging materials and retain for future use.	Retire con cuidado todos los materiales de embalaje y consérvelos para usarlos en el futuro.	Retirez soigneusement tous les matériaux d'emballage et conservez-les pour un usage ultérieur.
Keep all hardware parts and packaging out of reach of small children.	Conservez toutes les pièces matérielles et les emballages hors de portée des petits enfants.	Mantenga todas las piezas y embalajes de hardware fuera del alcance de los niños pequeños.
Choose a clean, level, spacious assembly area. Avoid hard surfaces that may damage the product.	Choisissez une zone d'assemblage propre, de niveau et spacieuse. Évitez les surfaces dures qui pourraient endommager le produit.	Elija una zona de ensamblaje limpia, nivelada y espaciosa. Evite superficies duras que puedan dañar el producto.
Ensure that you have all required contents for complete assembly.	Assurez-vous que vous avez tous les contenus requis pour l'assemblage complet.	Asegúrese de que tiene todos los contenidos necesarios para el ensamblaje completo.
Take care when lifting. Assemble the product in close proximity to where you intend to position the item.	Prenez soin de soulever. Assemblez le produit à proximité de l'endroit où vous comptez positionner l'élément.	Tenga cuidado al levantar. Ensamble el producto cerca de donde tiene la intención de posicionar el artículo.
Do not over tighten the screws and bolts as this may damage the threads.	Ne serrez pas trop les vis et les boulons car cela pourrait endommager les filets.	No apriete excesivamente los tornillos y pernos, ya que esto puede dañar los hilos.
Do not let children play with this product.	No permita que los niños jueguen con este producto.	Ne laissez pas les enfants jouer avec ce produit.
⚠ Risk of suffocation! Keep any packaging materials away from children.	⚠ ¡Riesgo de sofocación! Mantenga los materiales de embalaje lejos de los niños.	⚠ Risque d'asphyxie! Tenez tous les matériaux d'emballage à l'écart des enfants

Lamp Care Instructions	Instrucciones de lámparas	Entretien de la lampe
Carefully read through the instruction sheet before assembly and using the product.	Lea cuidadosamente la hoja de instrucciones (si fue proporcionada) antes de armar y utilizar la lámpara.	Avant de procéder à l'assemblage et à l'utilisation de la lampe, lisez attentivement le mode d'emploi.
Caution there is a risk of shock. Disconnect from power source before assembling or cleaning.	Peligro por descarga eléctrica. Desconecte la lámpara de la fuente de electricidad antes de armarla o limpiarla.	Pour éviter tout risque d'électrocution, débranchez la lampe de la prise électrique avant de procéder à l'assemblage ou au nettoyage de la lampe.
⚠ WARNING: Wires need to be connected to driver found in canopy and should not be connected directly to power source or a short may occur.	⚠ ADVERTENCIA: los cables deben estar conectados al conductor que se encuentra en el dosel y no deben conectarse directamente a la fuente de alimentación o se puede producir un cortocircuito.	⚠ AVERTISSEMENT: Nécessité de câbles à connecter au pilote trouvé dans la canopée et ne doit pas être connectée directement à la source d'alimentation ou un court-circuit peut se produire.
Only use the recommended bulb type and do not exceed the maximum wattage as it could cause fire.	Solo utilice el tipo de bombilla recomendado y no exceda la potencia eléctrica máxima ya que puede causar un incendio.	Afin d'éviter tout risque de feu, utilisez le type et la puissance d'ampoule recommandés.
Do not plug the product in if cord is torn or frayed.	No conecte la lámpara si el cable eléctrico está dañado o deshilachado.	Ne branchez pas la lampe si son cordon d'alimentation est déchiré ou effiloché

Cleaning & Maintenance	Limpieza y mantenimiento	Nettoyage et maintenance
On polished finishes, often using talc powder reduces the appearance of fingerprints and other smudges.	En acabados pulidos, a menudo usando polvo de talco reduce la aparición de huellas dactilares y otras manchas.	Sur les finitions polies, souvent en utilisant la poudre de talc réduit l'apparence des empreintes digitales et d'autres taches.
For respective shade surfaces, use the appropriate cleansers, i.e. glass cleaner, acrylic polish, and wood polish.	Para las respectivas superficies de sombra, utilice los limpiadores apropiados, es decir, limpiador de vidrio, esmalte acrílico y pulido de madera.	Pour les surfaces d'ombrage respectives, utilisez les nettoyants appropriés, c'est-à-dire le nettoyant pour vitres, le Vernis acrylique et le vernis à bois.
Clean with soft cloth and a mild detergent. DO not use abrasive cleaner.	Utilice un trapo limpio, suave y seco que no raye ni manche la superficie cuando quite el polvo.	Nettoyer avec un chiffon doux et un détergent doux. N'utilisez pas de nettoyant abrasif.
Periodically (every 90 days) make sure that the screws are fully tightened.	Periódicamente (cada 90 días) asegúrese de que los tornillos estén bien apretados.	Périodiquement (tous les 90 jours), assurez-vous que les vis sont bien serrées.
Prolonged exposure to heat sources may cause glazing, melting and scorching, or even cause color to fade.	La exposición prolongada a las fuentes de calor causa cristalización, derretimiento, quemadura y decoloración del tapizado.	Si le tissu subit une exposition prolongée aux sources de chaleur, il pourrait commencer à reluire, à roussir, à s'estomper ou même à se décolorer.

EN Contents

Before getting started, ensure the package contains the following components:

Antes de comenzar, asegurese de que el paquete contenga los siguientes componentes:

Avant de commencer, assurez-vous qu le paquet contienn les composants suivants

A

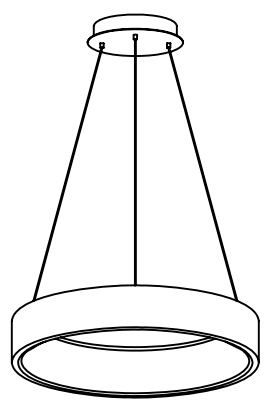

FIXTURE

X1

B

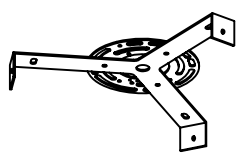

MOUNTING BRACKET

X1

C



#5-32*1" SCREW

X2

D

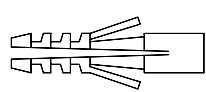

PLASTIC ANCHOR

X3

E

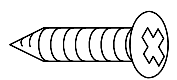

#5-32*1.5" SCREW

X3

F

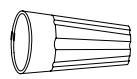

P3 WIRE NUTS

X3

1.

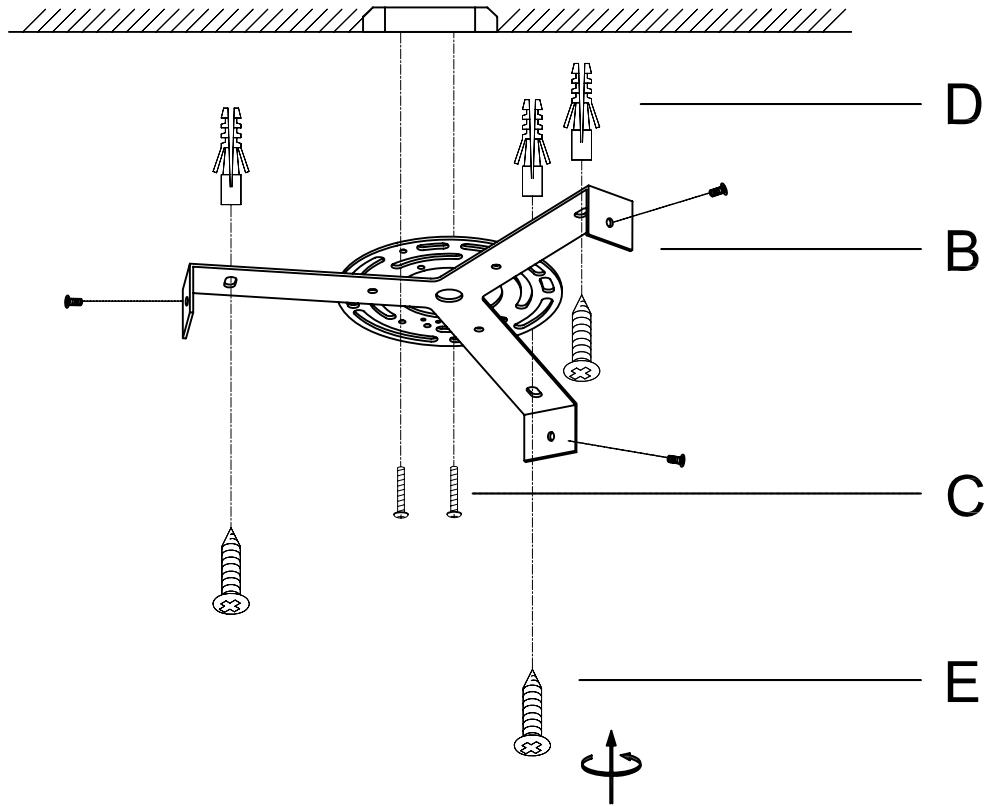

2.

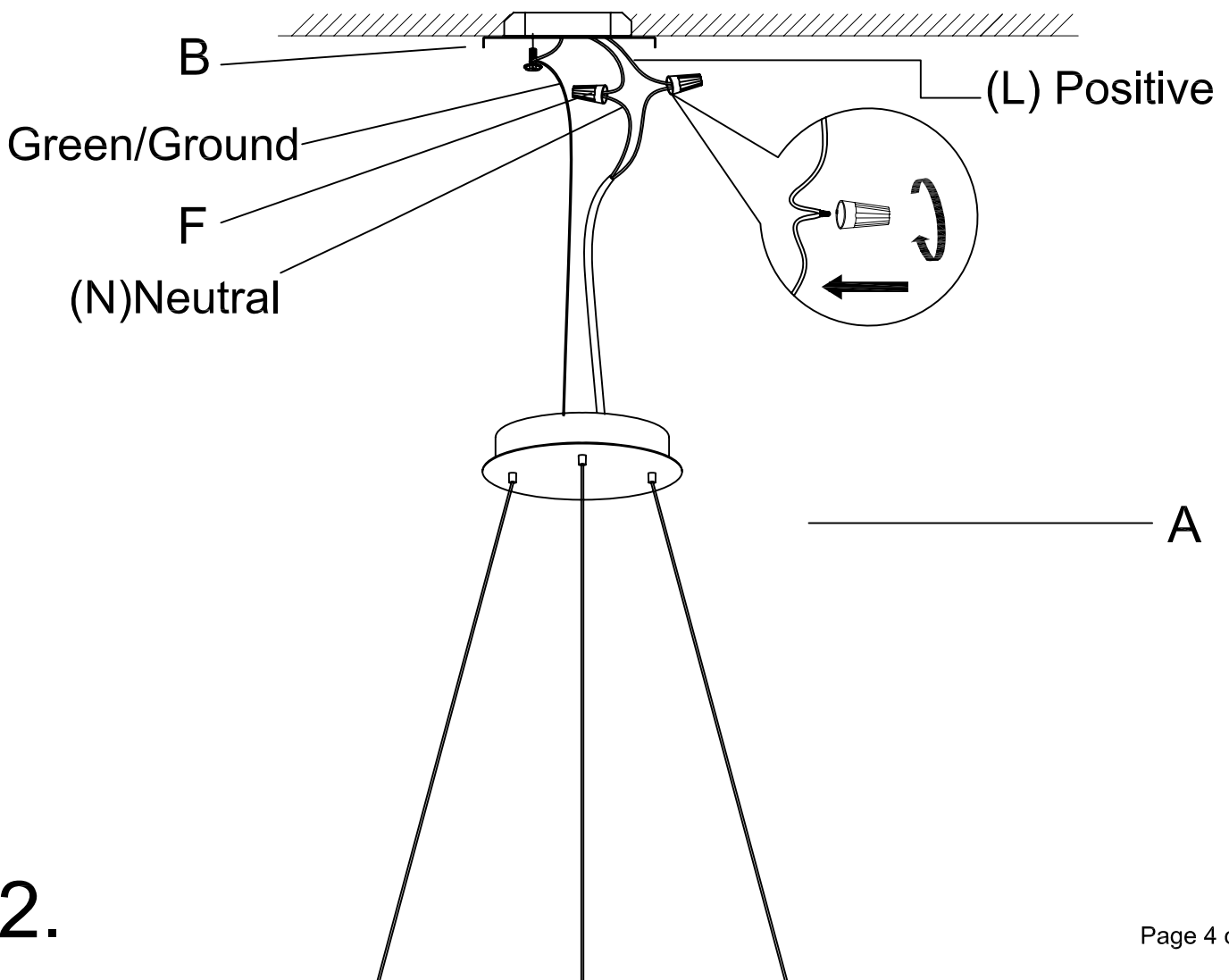

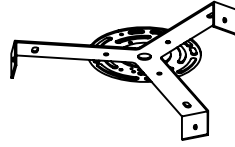

B

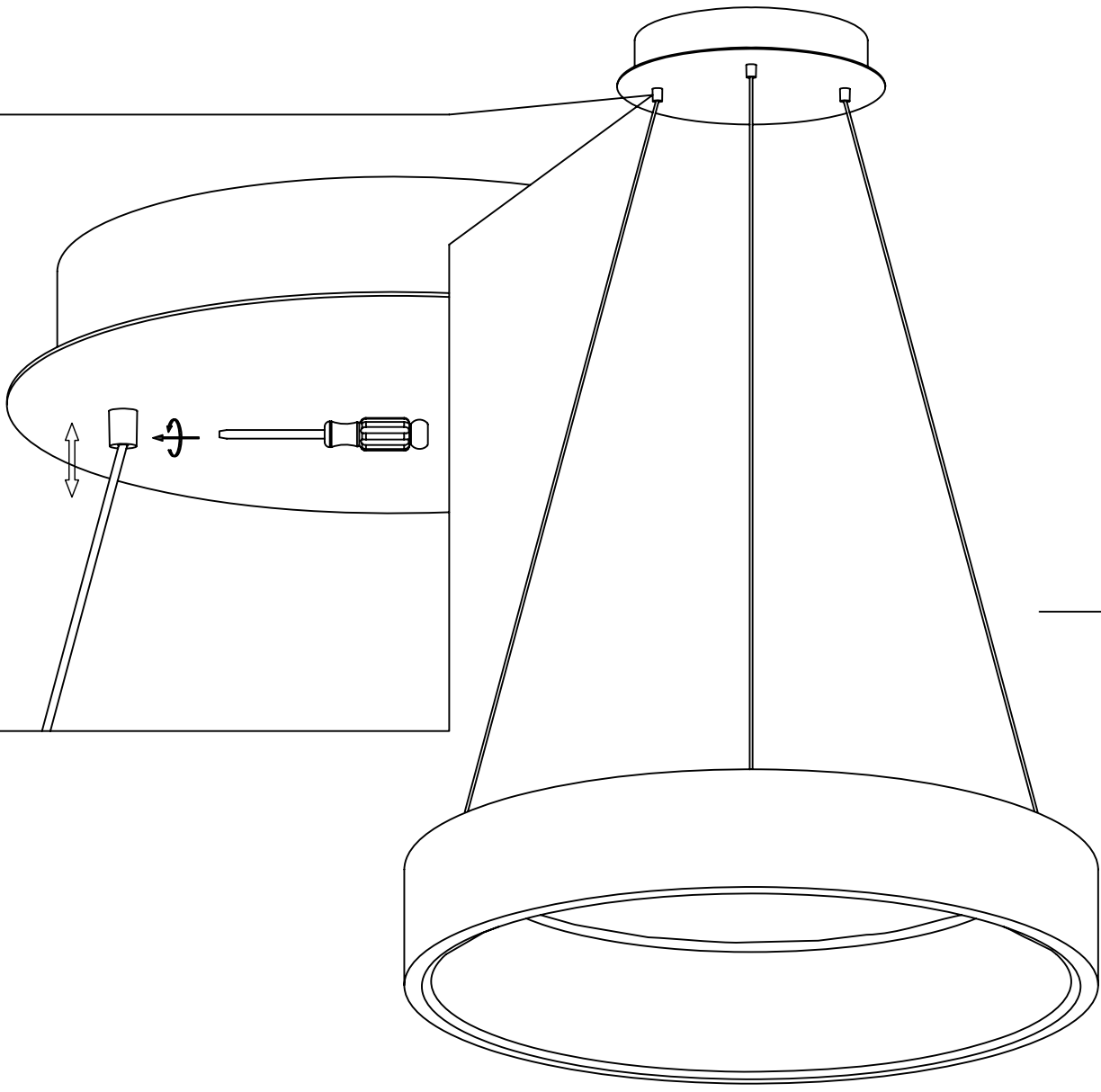

A



WIRING DIAGRAM (ONLY FOR REFERENCE)

DO NOT ATTEMPT TO CUT FACTORY CONNECTIONS WITHOUT QUALIFIED KNOWLEDGE. MODIFICATIONS MADE TO THIS PRODUCT WITHOUT THE CONSENT OF THE MANUFACTURER WILL VOID WARRANTY.

E31258

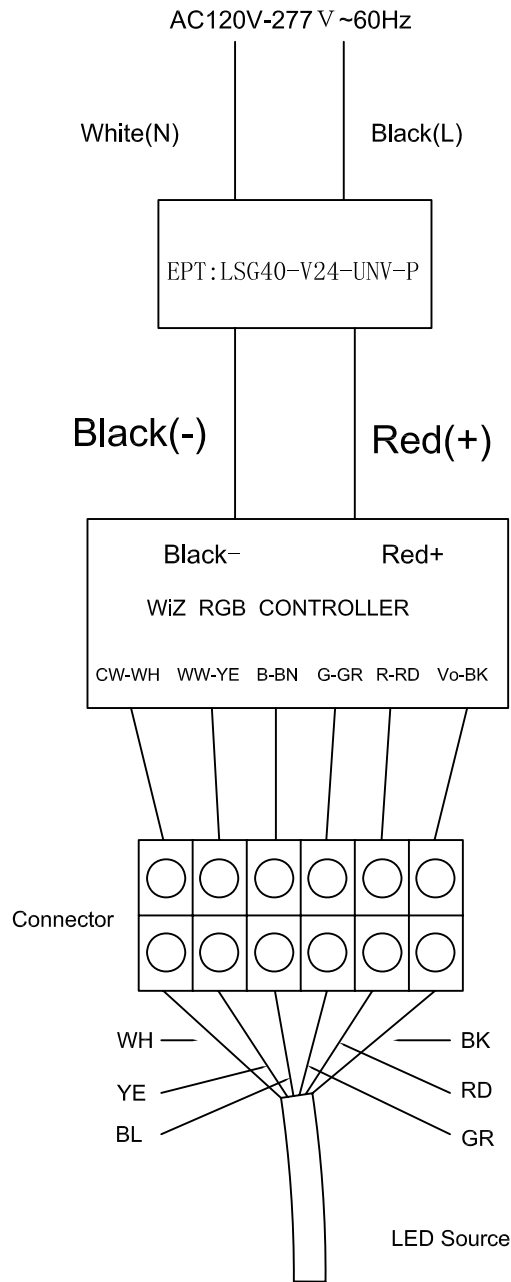

SCHEMATIC FOR GENERAL REFERENCE ONLY

IMPORTANT

Make sure that your dimmable LED fixture is paired with the correct dimmer type

NOTE: Notice the wiring diagram and wire color when connecting wires between Wiz controller and LED source

Must be installed by a licensed electrician with knowledge of electronic lighting systems



INSTALL LIGHT

DOWNLOAD WIZ APP

PAIR YOUR NEW LIGHT



STEP 1 DOWNLOADING THE WIZ APP

Make sure you've properly installed your light fixture prior to syncing device. Download the **Wiz App** from Google Play or the Apple App Store. (IF YOU HAVE NOT YET INSTALLED YOUR LIGHT, INSTRUCTIONS CAN BE FOUND IN THE PRIOR PAGES TITLED "ASSEMBLY INSTRUCTIONS.")

NOTE: The Wiz app **MUST CONNECT TO A 2.4GHz Wi-Fi NETWORK** IN ORDER TO PAIR YOUR LIGHTS.

STEP 2

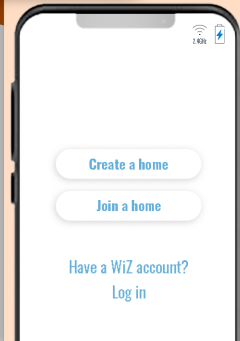

Create or join a home

STEP 3

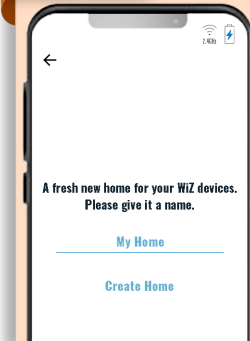

Name Your Home

STEP 4

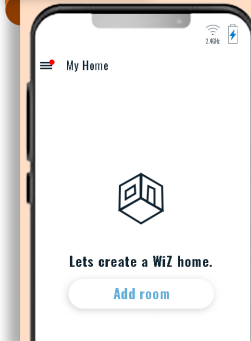

Add your rooms

STEP 5

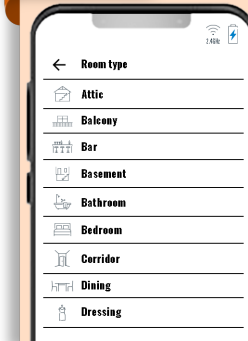

Choose your room

STEP 6

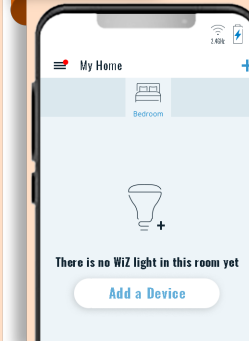

Add your devices

STEP 7

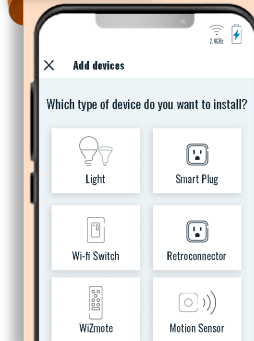

Select 'Type of device' and follow instructions

NOTE: Please allow up to 1 minute after initial startup, for fixture to pair.

TROUBLESHOOTING

PROBLEM	CAUSE	SOLUTION
Unable to find light fixture on the network	Light may not be in Connectivity Mode	Cycle the light switch connected to light ON/OFF 3 times to enter Pairing Mode .
Unable to operate light fixture with the connected light switch	Wiring Issue	Review and confirm the INSTALLATION instructions.
	No Electricity	Check that the power is ON at the connected light switch and circuit breaker.
Lights not responding to WIZ APP control	Network is not connected	Check wireless network connectivity.
	Light may not be paired correctly	Cycle the light switch connected to light ON/OFF 5 times to enter Pairing Mode .
	Permissions are not granted on mobile device	Check to see that permissions are granted for the WIZ APP.
Lights not connecting to the WIZ APP	Wi-Fi password is incorrect	Re-enter WiFi Password.
	Weak/low Wi-Fi signal	Check Wi-Fi signal to ensure you're within range of router.
	Wi-Fi not connected	Confirm Wi-Fi router is broadcasting a 2.4GHz signal. Re-connect.



The following importer is the responsible party:
LLC Sales, Inc. DBA Liteline USA
1209 Orange Street, Wilmington, DE, 19801
Liteline.com/contact-us

This device complies with part 15 of the FCC Rules. Operation is subject to the following two conditions: (1) This device may not cause harmful interference, and (2) this device must accept any interference received, including interference that may cause undesired operation.

Changes or modifications not expressly approved by the responsible party could void the user's authority to operate the equipment.

Note: This equipment has been tested to comply with the limits for a Class B digital device, pursuant to part 15 of the FCC Rules. These limits are designed to provide reasonable protection against harmful interference in a residential installation. This equipment generates, uses and can radiate radio frequency energy and, if not installed and used in accordance with the instructions, may cause harmful interference to radio communications. However, there is no guarantee that interference will not occur in a particular installation. If this equipment does cause harmful interference to radio or television reception, which can be determined by turning the equipment off and on, the user is encouraged to try to correct the interference by one or more of the following measures: (1) reorient or relocate the receiving antenna; (2) increase the separation between the equipment and receiver; (3) connect the equipment into an outlet on a circuit different from that to which the receiver is connected; consult the dealer or an experienced radio/TV technician for help.

RF Exposure Requirements:

This device complies with FCC RF radiation exposure limits set forth for an uncontrolled environment. The antenna(s) used for this transmitter must not be co-located or operating in conjunction with any other antenna or transmitter and must be installed to provide a separation distance of at least 20cm from all persons.

ISED Canada Compliance Statement:

This device contains licence-exempt transmitter(s)/receiver(s) that comply with Innovation, Science and Economic Development Canada's licence exempt RSS(s). Operation is subject to the following two conditions: (1) This device may not cause interference; and (2) This device must accept any interference, including interference that may cause undesired operation of the device.

Déclaration de Conformité ISDE Canada

L'émetteur/récepteur exempt de licence contenu dans le présent appareil est conforme aux CNR d'Innovation, Sciences et Développement Économique Canada applicables aux appareils radio exempts de licence. L'exploitation est autorisée aux deux conditions suivantes: (1) L'appareil ne doit pas produire de brouillage; et (2) L'appareil doit accepter tout brouillage radioélectrique subi, même si le brouillage est susceptible d'en compromettre le fonctionnement.

For more help contact WIZ support:

www.liteline.com/Wizsupport



Installez votre
luminaire

Téléchargez
l'application

Synchronisez votre
nouveau luminaire



ETAPE 1 TÉLÉCHARGER L'APPLICATION WIZ

Assurez vous d'installer votre luminaire correctement avant de le synchroniser. Téléchargez l'application **WIZ** depuis Google Play ou sur l'App Store. **(SI VOTRE LUMINAIRE N'EST PAS ENCORE INSTALLÉ, REFERREZ VOUS AUX INSTRUCTIONS EN DÉBUT DE SECTION SOUS LA RUBRIQUE "INSTRUCTIONS D'ASSEMBLAGE").**

NOTE: L'application WIZ **DOIT OBLIGATOIREMENT ÊTRE CONNECTÉE A UN RÉSEAU Wi-Fi 2.4Gz** afin de synchroniser vos luminaires.

ETAPE 2

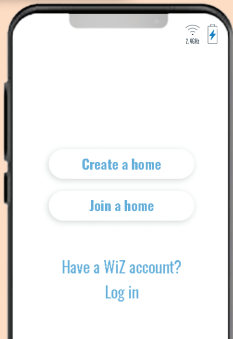

Créer un domicile
Joindre un domicile

ETAPE 3

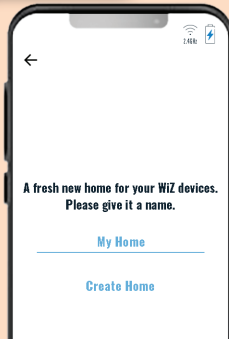

Nommez votre
Domicile

ETAPE 4

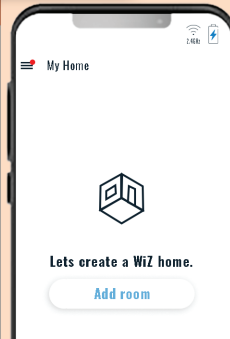

Ajoutez vos
pièces

ETAPE 5

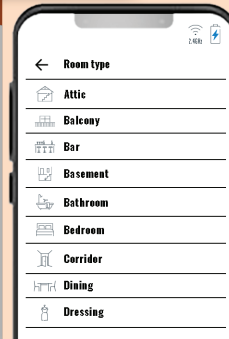

Choisissez votre
pièce

ETAPE 6

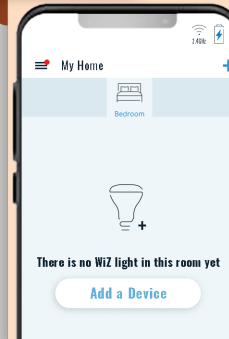

Ajouter vos
appareils

ETAPE 7

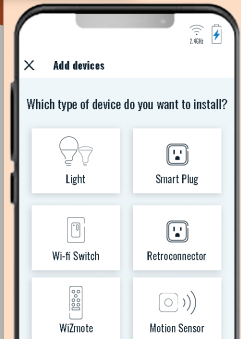

Sélectionnez 'Type of
device' et suivez
les instructions

NOTE: Apres la première installation, veuillez patienter 1 minute avant chaque mise à jour

DÉPANNAGE

PROBLÈME	CAUSE	SOLUTION
Luminaire introuvable sur le réseau	Luminaire pourrait ne pas être au mode de connectivité	Actionnez l'interrupteur connecté au luminaire trois fois (ALLUMÉ/ÉTEINT) pour passer au Mode de Jumelage .
Impossible d'actionner luminaire avec l'interrupteur connecté	Problème de câblage	Relisez les instructions d'INSTALLATION et confirmez.
	Pas d'électricité	Assurez-vous que l'interrupteur connecté et le disjoncteur du circuit sont sous tension.
Luminaire ne réagit pas à une commande de l'appli WIZ	Réseau non connecté	Vérifiez la connectivité au réseau sans fil.
	Luminaire n'est pas jumelé correctement	Actionnez l'interrupteur connecté au luminaire cinq fois (ALLUMÉ/ÉTEINT) pour passer au Mode de Jumelage .
	Permissions non accordées sur l'appareil mobile	Assurez-vous que les permissions sont accordées à l'appli WIZ.
Luminaire ne se connecte pas à l'appli WIZ	Mot de passe WiFi incorrect	Saisissez le mot de passe WiFi de nouveau.
	Signal WiFi faible	Assurez-vous d'être en-deça de la portée du répartiteur.
	WiFi non connecté	Assurez-vous que le répartiteur WiFi émet un signal de 2,4 GHz. Reconnectez-vous.



The following importer is the responsible party:
LLC Sales, Inc. DBA Liteline USA
1209 Orange Street, Wilmington, DE, 19801
Liteline.com/contact-us

This device complies with part 15 of the FCC Rules. Operation is subject to the following two conditions: (1) This device may not cause harmful interference, and (2) this device must accept any interference received, including interference that may cause undesired operation.

Changes or modifications not expressly approved by the responsible party could void the user's authority to operate the equipment.

Note: This equipment has been tested to comply with the limits for a Class B digital device, pursuant to part 15 of the FCC Rules. These limits are designed to provide reasonable protection against harmful interference in a residential installation. This equipment generates, uses and can radiate radio frequency energy and, if not installed and used in accordance with the instructions, may cause harmful interference to radio communications. However, there is no guarantee that interference will not occur in a particular installation. If this equipment does cause harmful interference to radio or television reception, which can be determined by turning the equipment off and on, the user is encouraged to try to correct the interference by one or more of the following measures: (1) reorient or relocate the receiving antenna; (2) increase the separation between the equipment and receiver; (3) connect the equipment into an outlet on a circuit different from that to which the receiver is connected; consult the dealer or an experienced radio/TV technician for help.

RF Exposure Requirements:

This device complies with FCC RF radiation exposure limits set forth for an uncontrolled environment. The antenna(s) used for this transmitter must not be co-located or operating in conjunction with any other antenna or transmitter and must be installed to provide a separation distance of at least 20cm from all persons.

ISED Canada Compliance Statement:

This device contains licence-exempt transmitter(s)/receiver(s) that comply with Innovation, Science and Economic Development Canada's licence exempt RSS(s). Operation is subject to the following two conditions: (1) This device may not cause interference; and (2) This device must accept any interference, including interference that may cause undesired operation of the device.

Déclaration de Conformité ISDE Canada

L'émetteur/récepteur exempt de licence contenu dans le présent appareil est conforme aux CNR d'Innovation, Sciences et Développement Économique Canada applicables aux appareils radio exempts de licence. L'exploitation est autorisée aux deux conditions suivantes: (1) L'appareil ne doit pas produire de brouillage; et (2) L'appareil doit accepter tout brouillage radioélectrique subi, même si le brouillage est susceptible d'en compromettre le fonctionnement.

Pour plus d'aide, veuillez contacter Wiz Support à l'aide du lien suivant

www.liteline.com/WIZsupport