

LED Mirror - Installation Instructions

James Martin Vanities always recommends you hire or consult a professional contractor when installing our products

Note: This mirror is not intended for outdoor use

IMPORTANT: Please read all instructions prior to beginning the installation of this mirror

- Make sure the installation area is free of clutter.
- Turn off electricity including wall switch's.
- Do not modify wires in anyway
- Always use two or more person when hanging mirrors

- **Parts included**

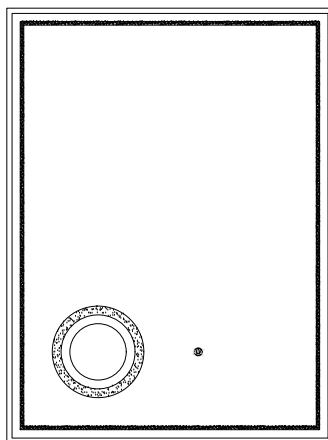

Mirror



Drywall Anchors X 2pcs
(Ø13*50)



Screws X 2pcs
(68*20)

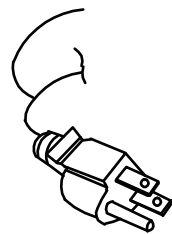

Electrical Cord
(attached to back of mirror)

FEATURES

- 5mm copper free silver mirror
- High output LED light:3100-3200LM,4000K CCT
- Touch switch for surface LED

CODES / CERTIFICATIONS

- 5020102



901-M29.5-GW TAMPA MIRROR Mirror Weight: 33 lbs (15kgs)

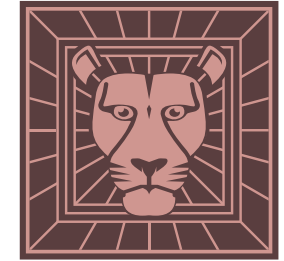

Pre-Installation Notes

- 120 Vac 60Hz wall outlet location - Required for source power
- Mirror hangs in Portrait orientation
- Includes hardware with easy installation via Plug and Hang System

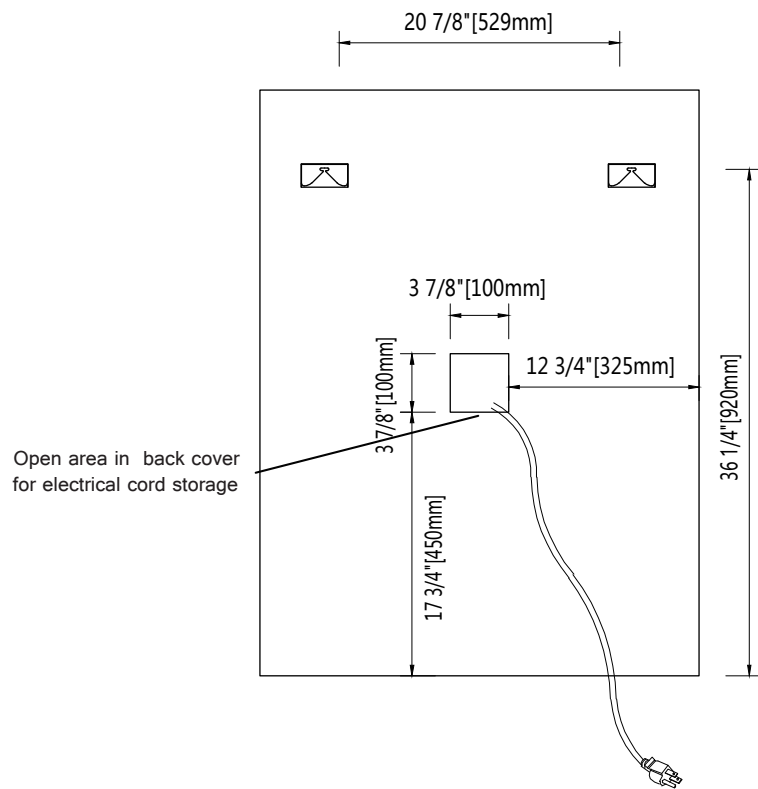

Back view

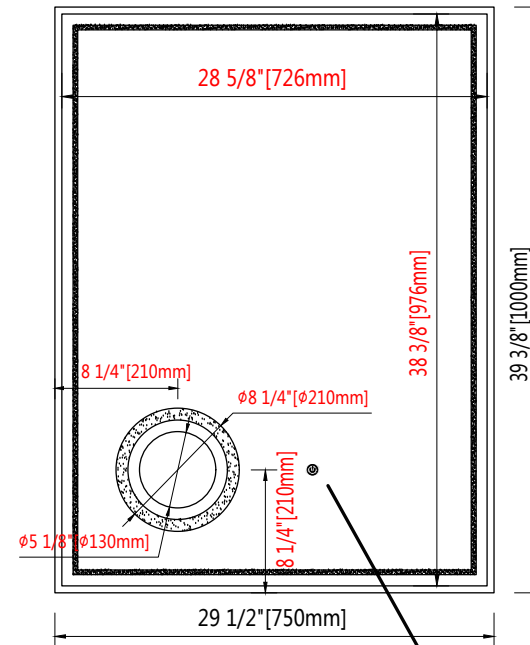

Front view



Touch the Sensor switch

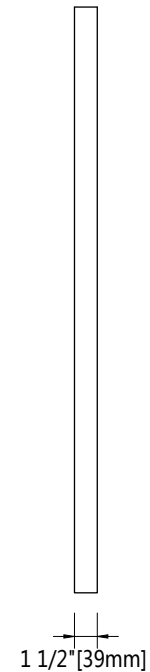

Side view

901-M29.5-GW TAMPA MIRROR Mirror Weight: 33 lbs (15kgs)

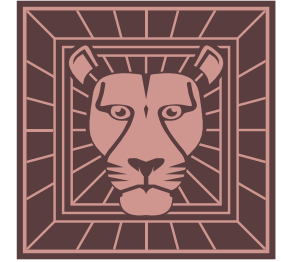

Tools required

Screw driver

Drill with 3/8" bit

Pencil

Measuring Tape

wrench

level

The hammer

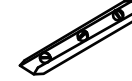
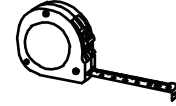
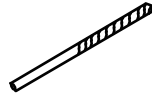

1 Measure the distance between the bottom of the mirror and point a. Measure the distance between c and d

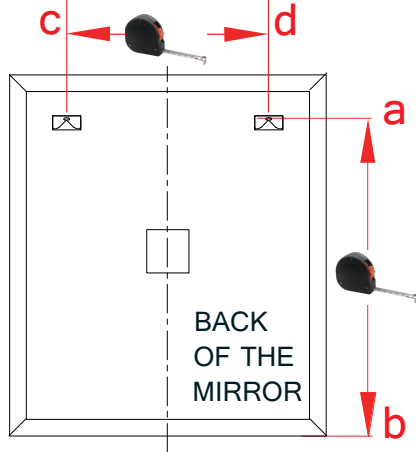

2 Draw a horizontal line from the point a using a level

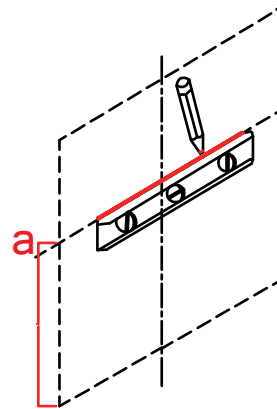

3 Draw point c and point d

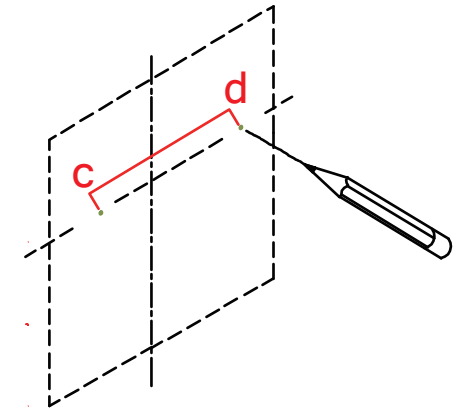

4 Drill the holes on the wall and insert the drywall anchors into the holes.

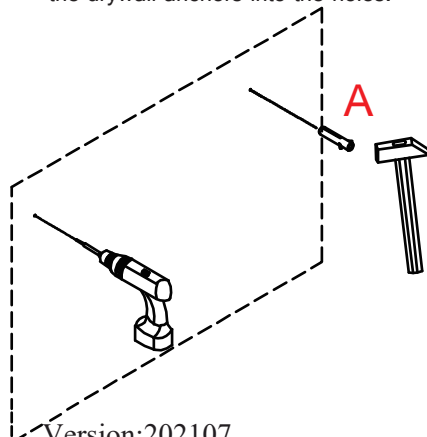

5 Insert the screws into the drywall anchors and reserve 16mm on the outside

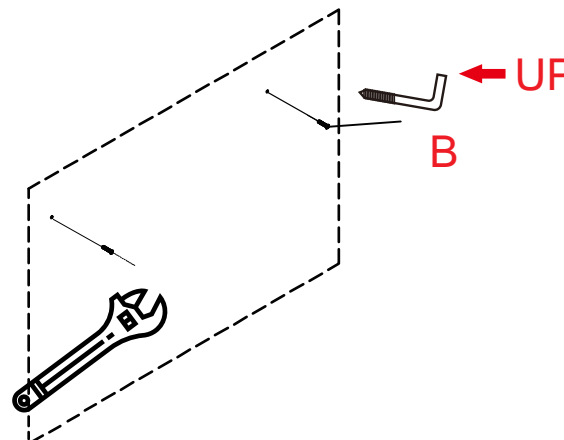

6 Hang the mirror on the screws

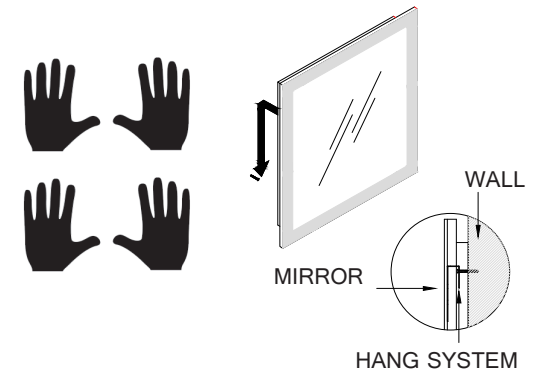

NOTE: Always use two or more people when hanging mirrors

HANG SYSTEM

901-M29.5-GW TAMPA MIRROR

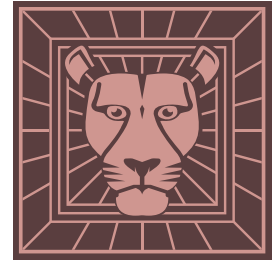

- Care and Cleaning Instructions for Mirrors

- CLEANER

The best and safest cleaner for a mirror is clean, warm water used with a soft cloth. Be careful not to allow the edges of the mirror to get or remain wet over a period of time. If using a commercial glass or mirror cleaner, be sure to use a standard brand of mirror cleaner that does not contain ammonia or vinegar.

- APPLICATION

Never spray any cleaner directly on to a mirror. Instead apply the cleaner to a soft cloth and then wipe the mirror.

- CLOTHS

Always use soft, grit-free cloths when cleaning a mirror to reduce chances of scratching the surface.

- FINISH

Be sure to dry all joints and edges thoroughly to be certain no commercial cleaner comes in contact with the edge and backing.

901-M29.5-GW TAMPA MIRROR

MANUAL INSTRUCTION:

- 1) Short Touch the switch button (<1s) to turn the light and defogger ON/OFF.
- 2) Long Touch the switch button (>1s) to activate the dimming function. Adjust the light to the appropriate brightness.

ELECTRICAL SAFETY INSTRUCTIONS:

All connections must be installed by a licensed electrician, in accordance with current building codes. Consult a qualified electrician.

IMPORTANT:

Always switch off the electrical supply at the main during installation and maintenance. It is recommended that the circuit breaker is switched off for the necessary circuit before installation commences.

Fitting in Bathrooms is subject to the appropriate building code Regulations. This product is NOT suitable for outside zones. It is also Not suitable for installation in saunas, steam rooms or shower cubicles. This product is only suitable for permanent installation. **DO NOT** connect to a trailing plug and socket outlet. This product is only suitable for indoor use. Do not attach the product to surfaces that are damp or otherwise electrically conductive.

INSTALLATION CARE & SAFETY:

Wear suitable eye protection when drilling. Take care when using power tools. Beware of hidden cables or pipes. Take care if drilling on tiled surfaces in case the drill slips. A piece of masking tape applied to the wall before marking out the fixing holes will stop the drill from wandering.

CLEANING:

It is recommended that the unit is cleaned with a soft,dry, non abrasive cloth when turned off. Never use cleaning agents or abrasive materials on any type of surface finish. Do not allow moisture to come into contact with the electrical components.

IMPORTANT:

DO NOT strike glass components with hard or pointed items. DO NOT place very hot or very cold items against or in close proximity to glass surfaces unless an adequately thick insulation material is used to prevent such items coming in contact with the glass. The nominal thickness of the mirror glass used in this product is 1/5" and is film backed for safety. If the glass becomes chipped or broken replace immediately.

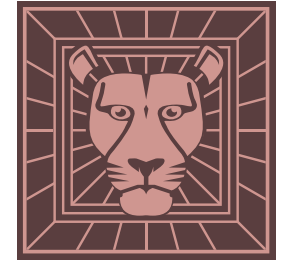

901-M29.5-GW TAMPA MIRROR



IMPORTANT SAFETY INSTRUCTIONS:

When using an electrical furnishing, basic precautions should always be followed, including the following. Read all instructions before using (this furnishing).

DANGER - To reduce the risk of electric shock:

Always disconnect this furnishing from the electrical outlet before cleaning.

WARNING -To reduce the risk of burns, fire, electric shock, or injury to persons.

- 1 -Disconnect from outlet before putting on or taking off parts.
- 2 -Close supervision is necessary when this furnishing is used by, or near children, invalids, or disabled persons.
- 3 -Use this furnishing only for its intended use as described in these instructions. Do not use attachments not recommended by the manufacturer.
- 4 -Never operate this furnishing if it has damaged, not working properly, dropped or damaged, or dropped into water. Return the furnishing to a service center for examination and repair
- 5 -Keep the cord away from heated surfaces.
- 6 -Never operate the furnishing with the air openings blocked. Keep the air openings free of lint, hair, and the like.
- 7 -Never drop or insert any object into any opening.
- 8 -Do not use outdoors.
- 9 -Do not operate where aerosol (spray) products are being used or where oxygen is being administered.
- 10 -To disconnect turn all controls to the off position, then disconnect from outlet.
- 11 -For grounded products the following statement:

"WARNING: Risk of Electric Shock - Connect this furnishing to a properly grounded outlet only. See Grounding Instructions.

SAVE THESE INSTRUCTIONS

12 -GROUNDING INSTRUCTIONS

This product must be connected to a grounded metal, permanent wiring system, or an equipment-grounding conductor must be run with the circuit conductors and connected to the equipment-grounding terminal or lead on the product.