

### Features

- Adjustable rotation on outlet extension tube.
- Slip-fit inlet.
- Cleanout plug.
- Flange

### Material

- Brass

### Installation

- Intended for console table installations.



### Codes/Standards











ASME A112.18.2/CSA B125.2

### KOHLER® One-Year Limited Warranty

See website for detailed warranty information.

### Available Color/Finishes

*Color tiles intended for reference only.*

Color	Code	Description
	CP	Polished Chrome
	SN	Vibrant® Polished Nickel
	AF	Vibrant® French Gold
	PB	Vibrant® Polished Brass
	BGD	Vibrant® Moderne Brushed Gold
	BN	Vibrant® Brushed Nickel
	BV	Vibrant® Brushed Bronze
	2BZ	Oil-Rubbed Bronze
	BL	Matte Black
	0	White
	7	Black Black™

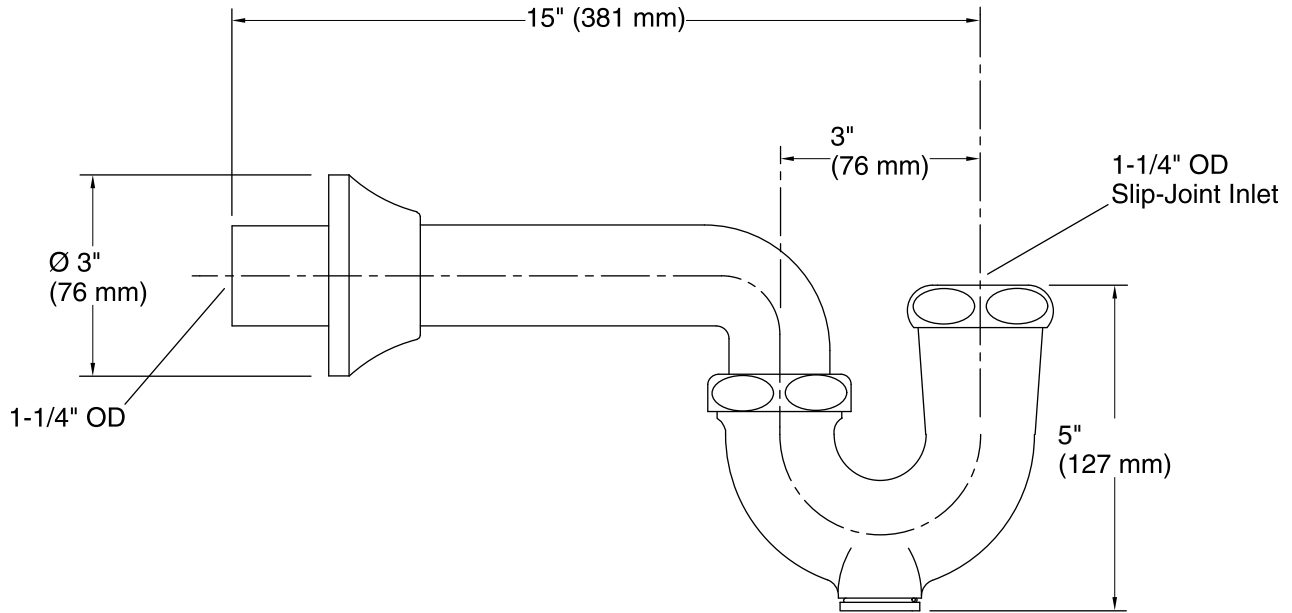

### Technical Information

All product dimensions are nominal.

### Notes

Install this product according to the installation guide.