

SVANGE 2436L Wall Mirror - Specification Sheet



Features

- Dimmable LED task lighting
- Integrated touch sensor control with memory
- Energy efficient LED lighting 6000K
- 3100 Lumens
- CRI 90+
- Integrated Defogger

Construction

- Quality polished edge mirror
- Single phase wire installation
- 5 MM Silver Backed Copper Free
- Installation Either Surface Mount (Side Mirror Trim Panels included) or Recessed
- Includes installation hardware

Codes/Standards Applicable

- Conforms to UL Std. 962
- Cert. to CSA Std. C22.2 No.250.0-08
- ETL Intertek 5004931

Electrical System

- 120Vac, 60Hz, 53W
- Electric Current: 0.44A
- Wattage: 53W

Model

- SVANGE 2436L Left Swinging Door
- Included models in this configuration:
Cabinet 1 = 2436L

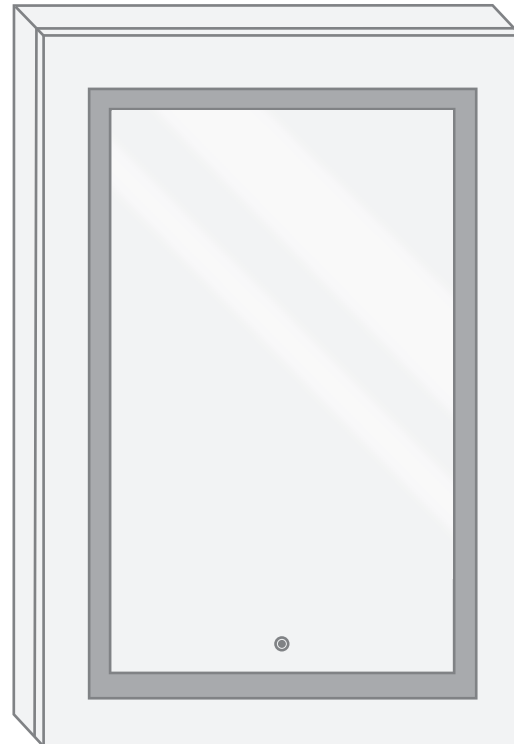

Outlet

- Performance Requirements: Contains the required Supervisory Circuit with the Auto-Monitoring Function as noted by UL 1310
- Input Voltage: Min 112Vac, Nom 125Vac, Max 137Vac
- Frequency: 60Hz
- Front Receptacle Current: 102-132VAC Nominal 15A
- USB Output Current: 5VDC Nominal 4A

CABINET CONFIGURATION

- Included models in this configuration:
Cabinet 1 = 2436L

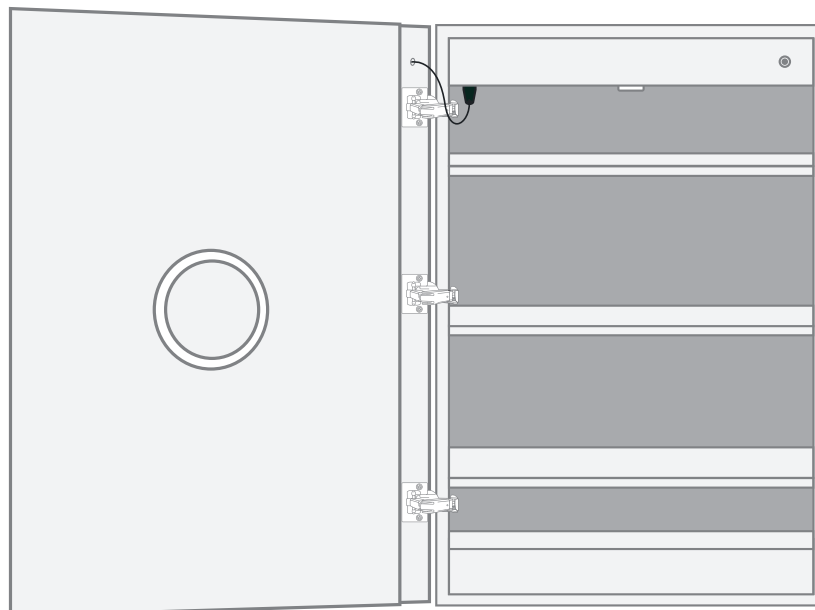
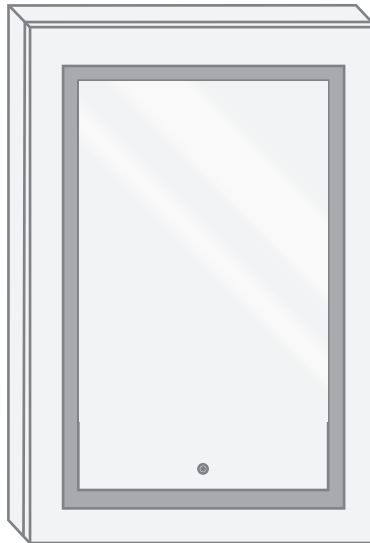

SVANGE 2436L Wall Mirror - Specification Sheet

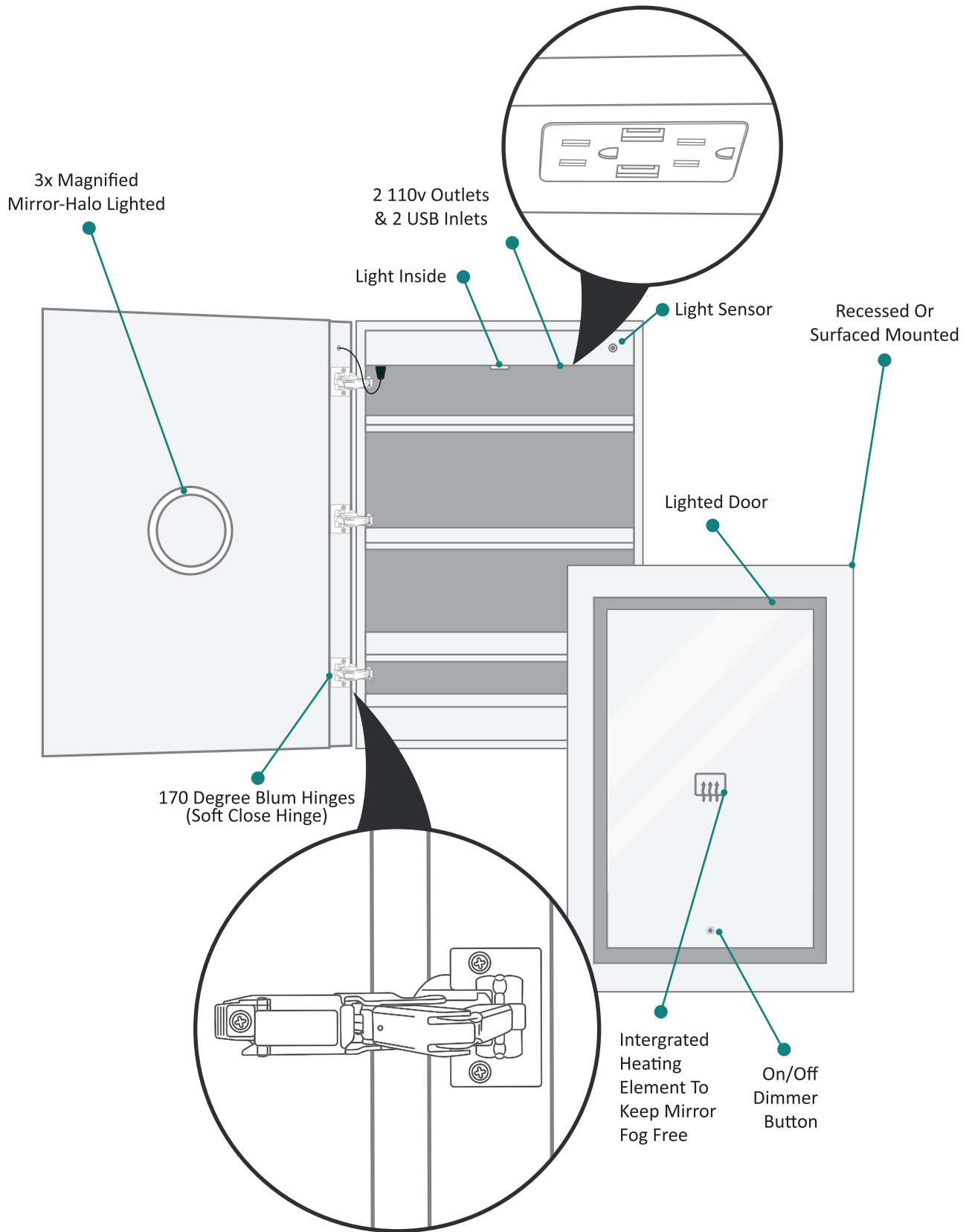

SVANGE 2436L Wall Mirror - Specification Sheet

SURFACE MOUNT

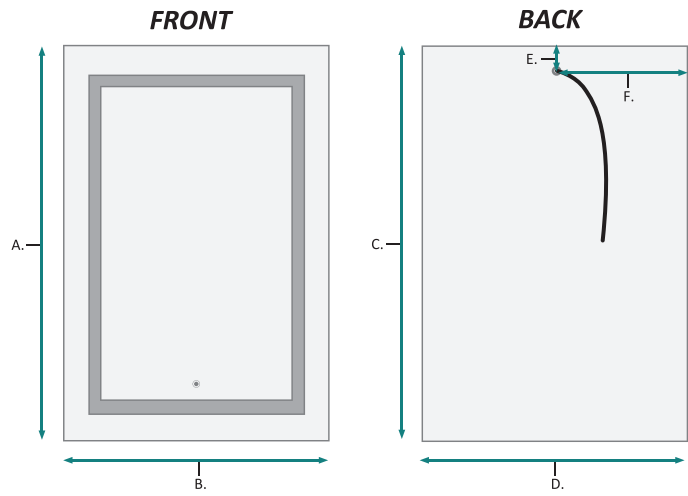
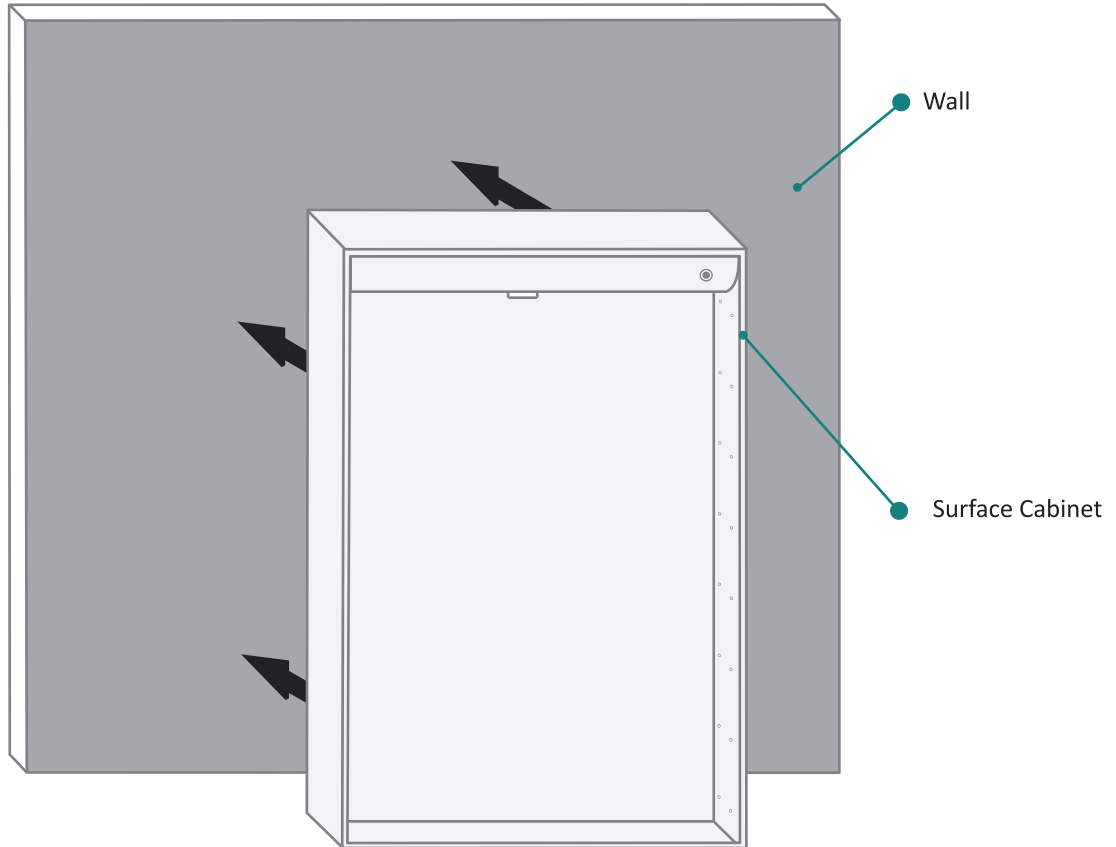

FRONT & BACKS

MODEL	A	B	C	D	E	F
SVANGE2436L	36	24	36	24	1-1/8	12

These measurements are for reference, for best results we suggest you measure actual product as small variations in size are possible

SVANGE 2436L Wall Mirror - Specification Sheet

RECESS MOUNT

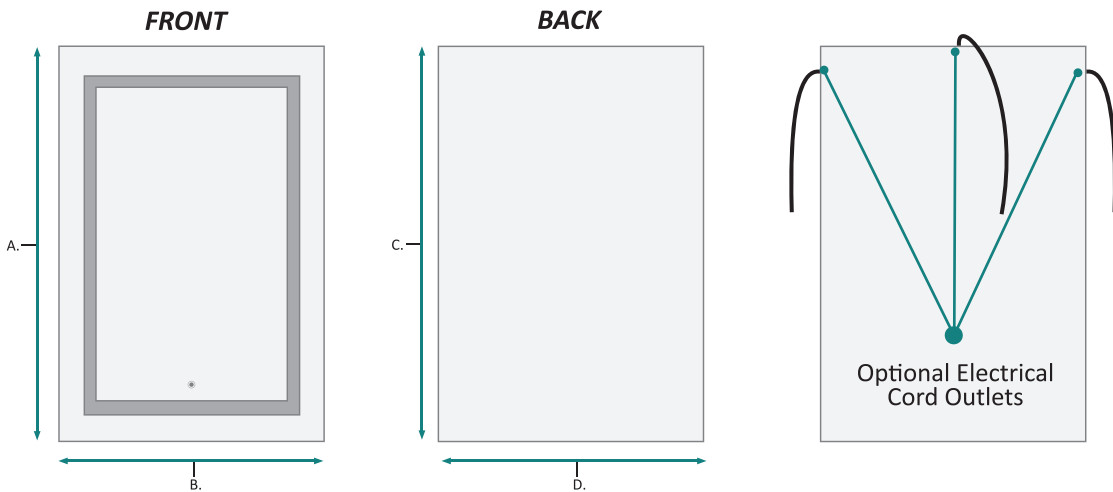
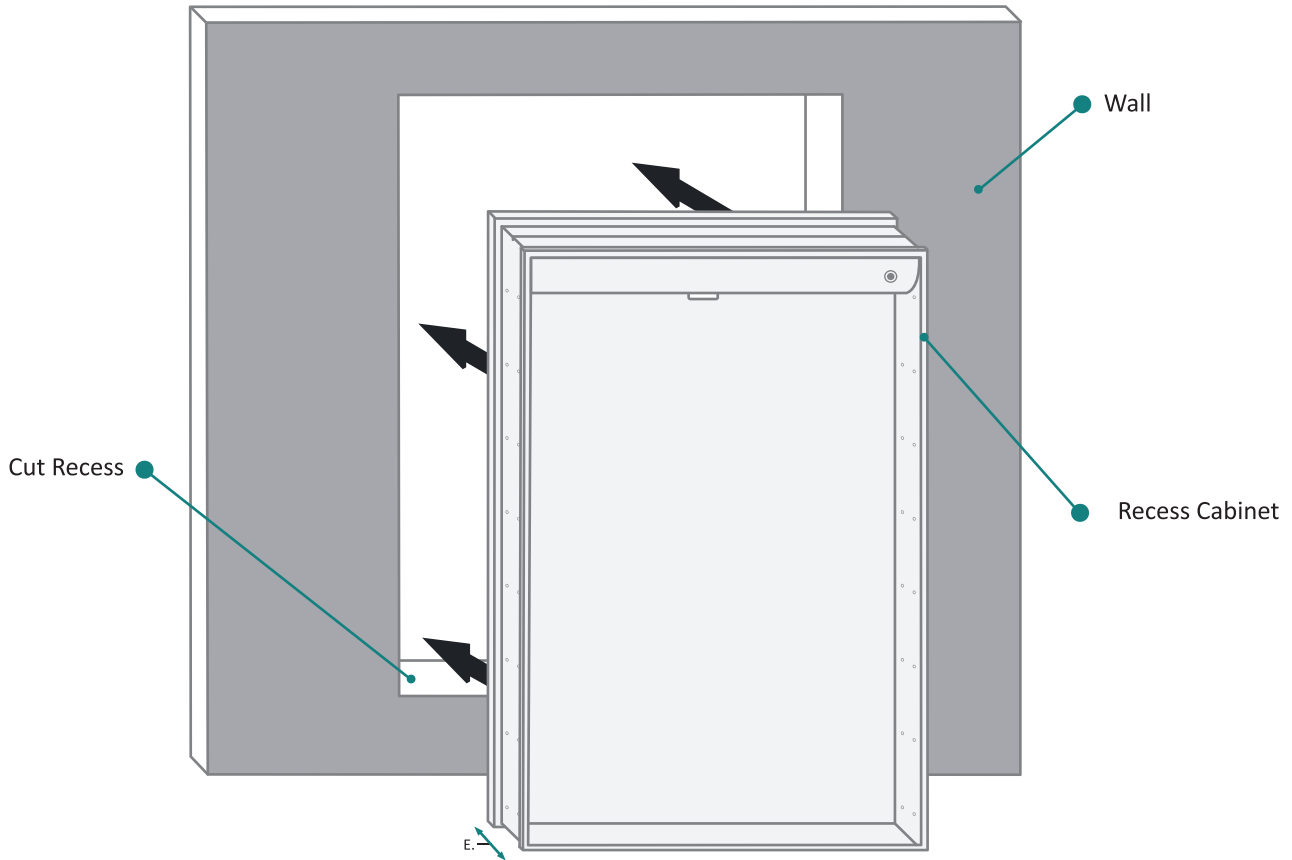

FRONT & BACK

MODEL	A	B	C	D	E
SVANGE2436L	36	24	35-1/8	23-1/8	3-1/2

These measurements are for reference, for best results we suggest you measure actual product as small variations in size are possible

RECESS INSTALLATION OPTIONAL ELECTRICAL CORD LOCATIONS

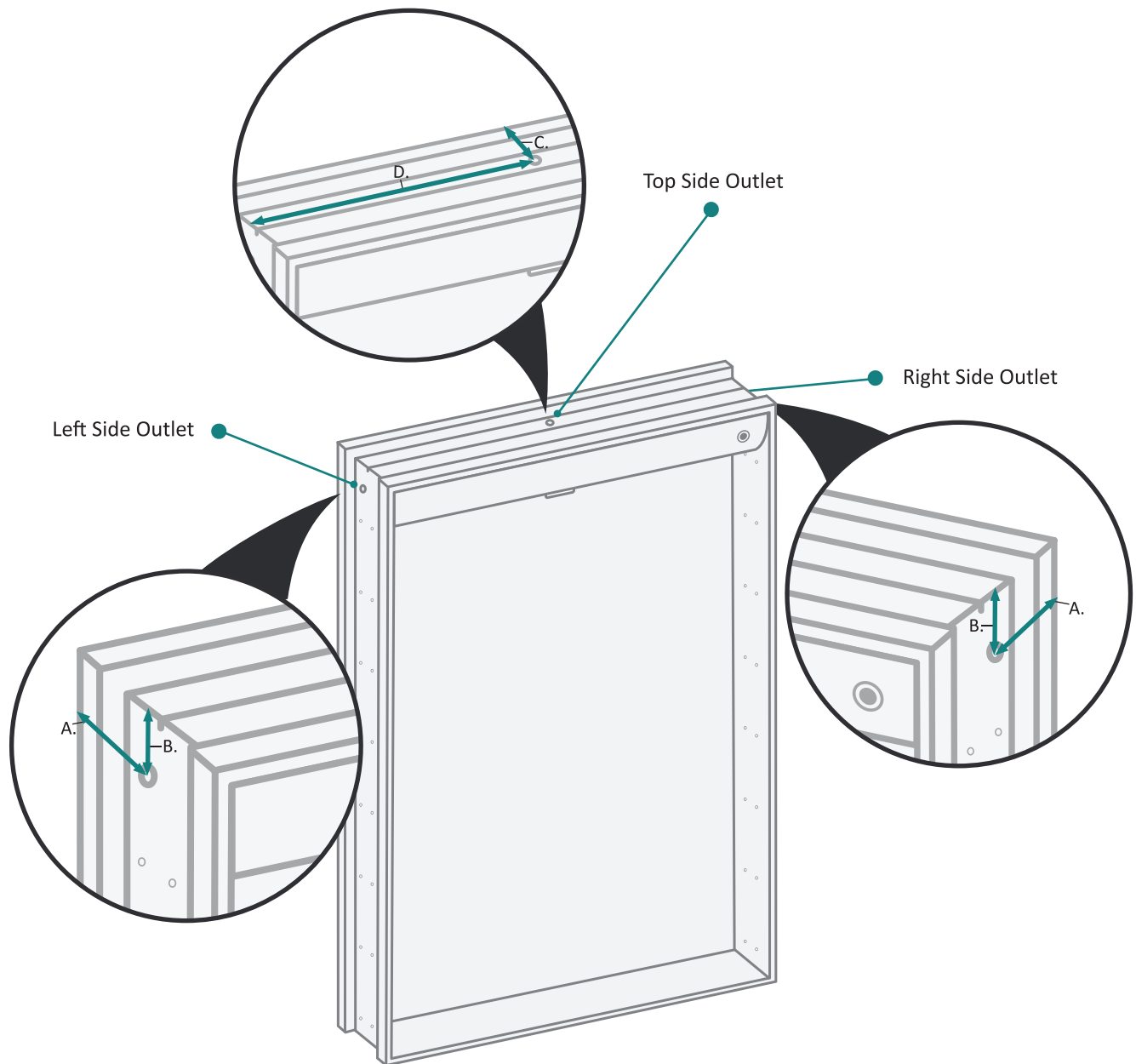

ELECTRICAL CORD LOCATIONS

MODEL	A	B	C	D
SVANGE2436L	1-1/8	1-1/8	1-1-8	12

These measurements are for reference, for best results we suggest you measure actual product as small variations in size are possible

SVANGE 2436L Wall Mirror - Specification Sheet

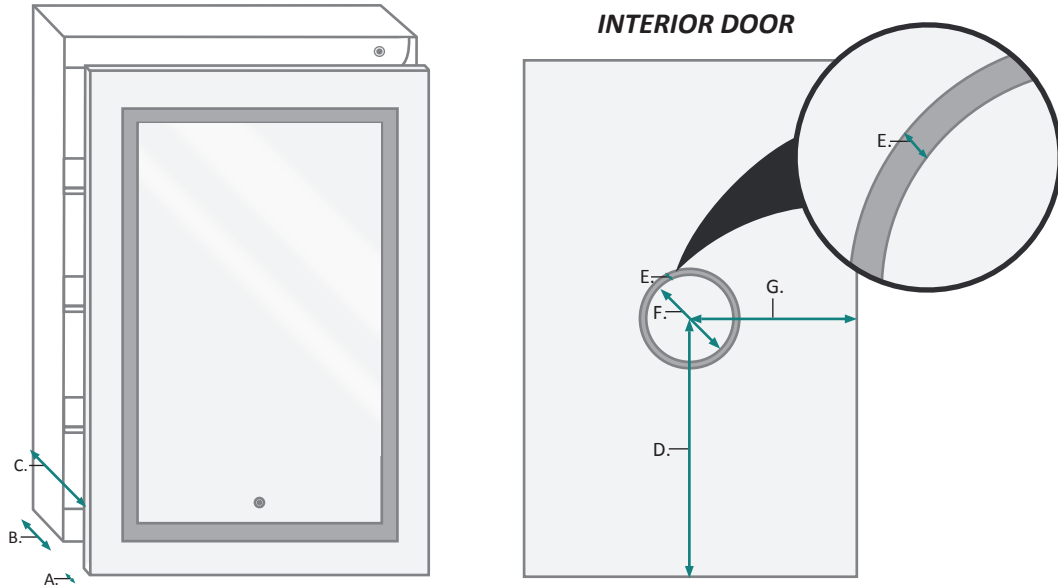

DOOR & CABINET

MODEL	A	B	C	D	E	F	G
SVANGE2436L	7/8	3-1/2	5	18	3/8	5-1/4	13

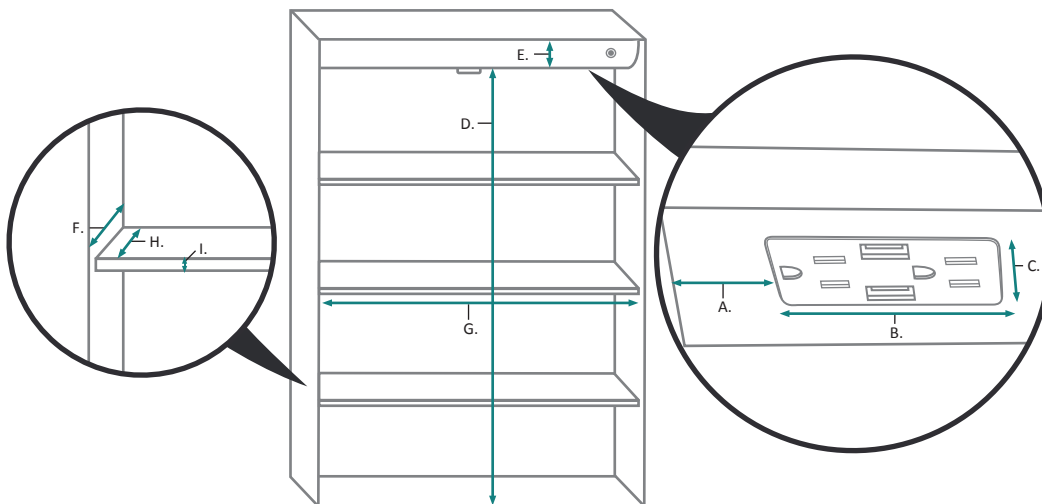

INTERIOR CABINET

MODEL	A	B	C	D	E	F	G	H	I
SVANGE2436L	3-3/4	5-5/8	1-1/4	32	2-1/4	3-5/8	22-1/4	2-3/8	3/8

These measurements are for reference, for best results we suggest you measure actual product as small variations in size are possible