

LED Flush Mount

FM43315-5CCT

INSTALLATION SHEET

START FROM HERE

- Make sure **POWER** is **COMPLETELY OFF** at the fuse box
- Have your fixture installed by a qualified licensed electrician
- Prepare everything in a clear area
- Wear gloves at all times during this installation
- Read instructions carefully before you start assembly
- Keep this installation sheet for future reference

Please Note:

- This Kuzco LED fixture comes with pre-wired LED module(s)
- Unless instructed, Do Not touch any part of the LED module(s) as any unnecessary contact with the module could cause permanent damage
- For dimming, an ELV (Electronic Low Voltage) type of dimmer is required
- 120V input

Technical Support: 1-855-855-8926

- 1.** Remove fixture from its original package
- 2.** Attach crossbar (**1c**) to electrical junction box (**1a**) using screws provided (**1e**) in hardware package
- 3.** Make proper electrical connections (black to hot "L", white to neutral "N", ground to "GND") with wire nuts (**1b**) provided in hardware package
- 4.** Install Pan-Head Crossbar Mounting Screws (**1d**) halfway into threaded holes on crossbar (**1c**). Align keyholes on backplate (**2a**) and module to Pan-Head Crossbar Mounting Screws (**1d**) heads, insert and turn, and then secure with screw driver.
- 5.** Secure backplate (**2a**) to ceiling with additional screws (**1g**) and anchors (**1f**) if necessary
- 6.** Choose color temperature by using slider (**5a**)
- 7.** Twist shade (**3a**) onto backplate (**2a**) to secure

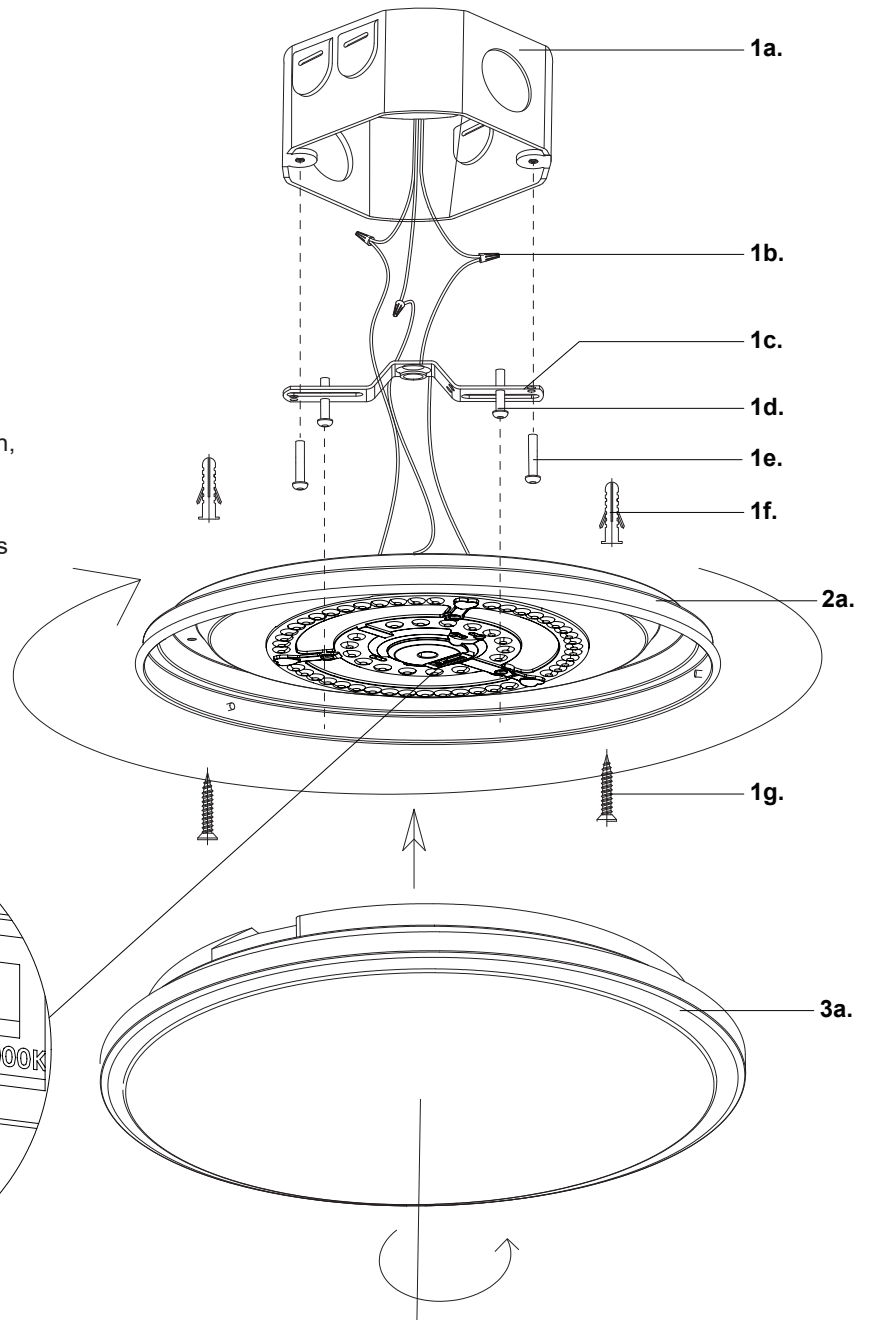

KUZCO

19054 28th Avenue Surrey, BC Canada V3Z 6M3
T: 604 538 7162 TF: 1-855 85 KUZCO F: 604 538 7196
W: kuzcolighting.com
20230926