

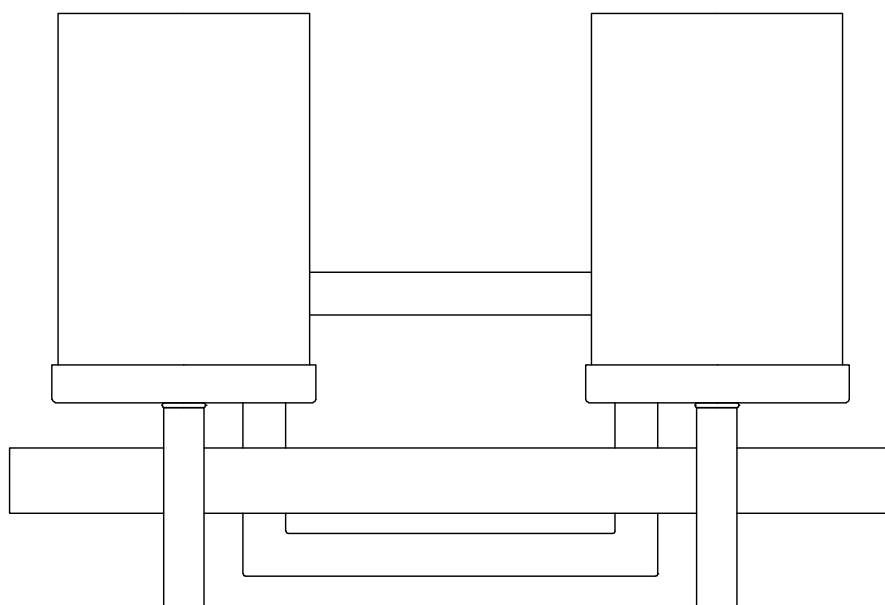

**PRODUCT NAME:** Tetra 2-Light Wall Sconce  
**ITEM NUMBER:** 2152

**Please consult your electrician for hanging fixture and wiring.**



**Bulb(not included): 2-60 Watt Medium Base Bulbs**

**IMPORTANT:** Turn off the power at the main fuse or circuit breaker box before starting installation

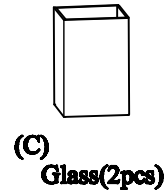
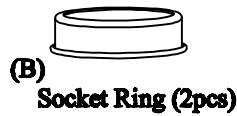
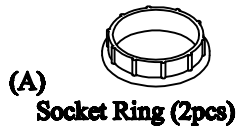

Locate all hardware & components before discarding packaging

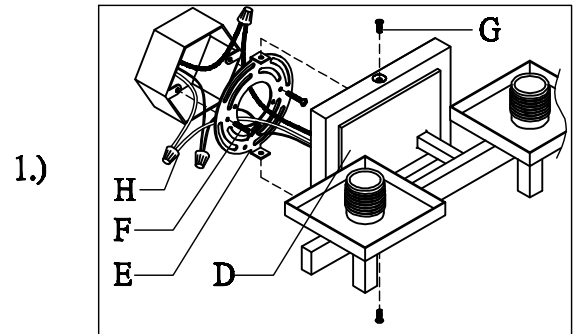
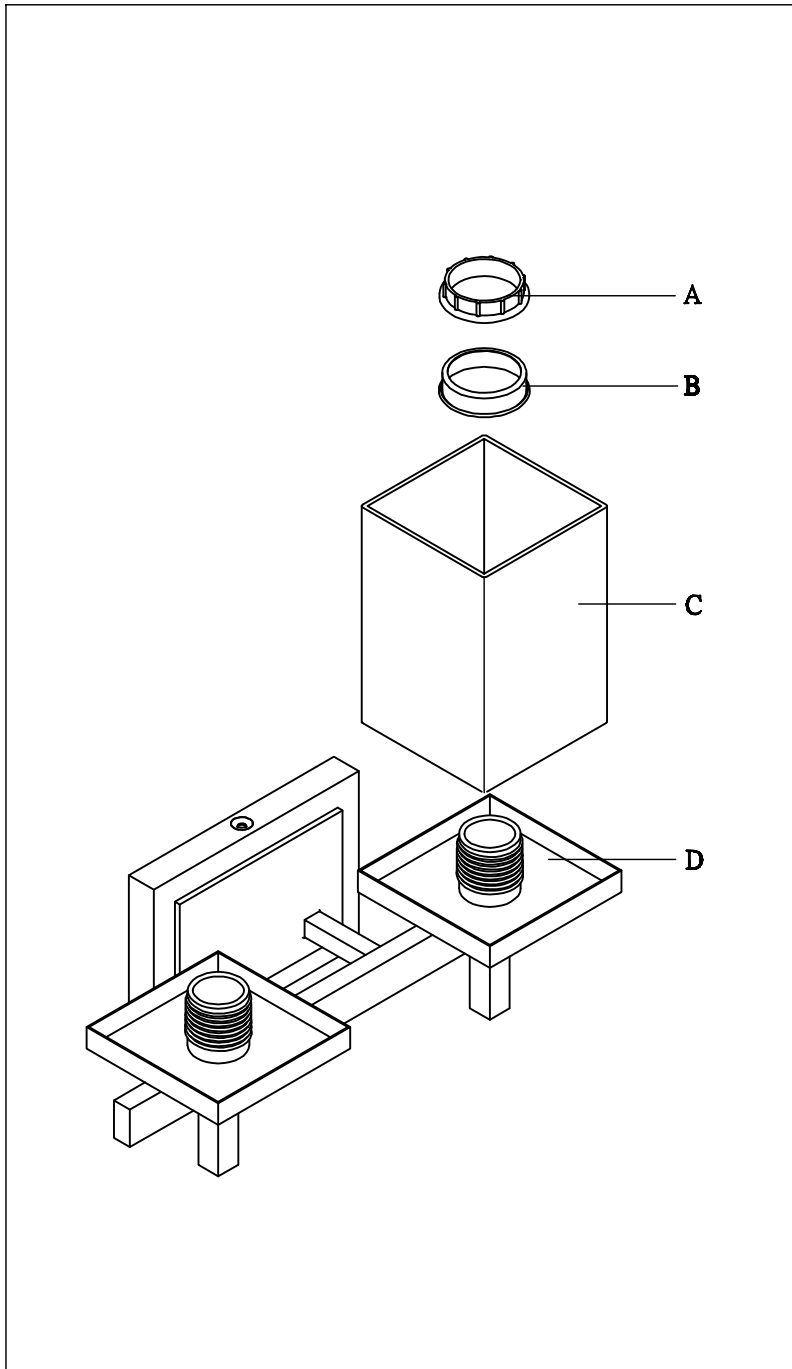

1.) **Step.1:** Remove mounting bracket (E) from fixture and install to electrical box. Then wire fixture to wires in outlet box. Copper wire is for Ground. Attach back plate to mounting bracket(E) and tighten screws (G) so fixture meets wall.

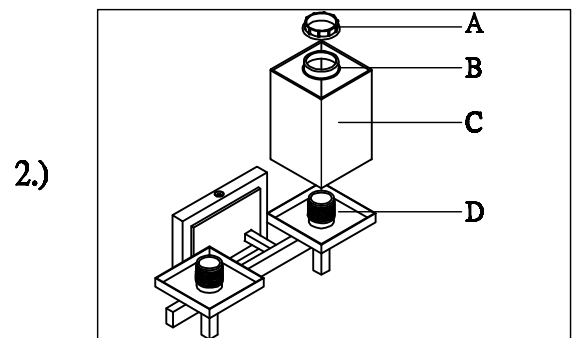

2.) **Step.2 :** Use the socket ring (A) & (B) to secure glass (C) on socket (D).

**Cleaning & Care:**

Clean with soft cloth and a mild detergent. Do not use abrasive cleaner.