

Installation Instructions

NUTP51 / NUTP81 / NUTP71

Continuous Tape

READ PRIOR TO ATTEMPTING INSTALLATION
ALWAYS TURN OFF MAIN POWER BEFORE INSTALLATION
INSTALLATION SHOULD BE CARRIED OUT BY YOUR LOCAL ELECTRICIAN

ITEM NO.	DESCRIPTION
NUTP51-W100LED927	Hybrite Continuous Tape, 100' (32' Max Run), 27K
NUTP51-W100LED930	Hybrite Continuous Tape, 100' (32' Max Run), 30K
NUTP51-W100LED942	Hybrite Continuous Tape, 100' (32' Max Run), 42K
NUTP81-W100LED930	High-Output Continuous Tape, 100' (20' Max Run), 30K
NUTP81-W100LED942	High-Output Continuous Tape 100' (20' Max Run), 42K
NUTP71-W100LED927L	Standard Continuous Tape 100' (64' Max Run), 27K
NUTP71-W100LED930L	Standard Continuous Tape 100' (64' Max Run), 30K
NUTP71-W100LED942L	Standard Continuous Tape 100' (64' Max Run), 42K

IMPORTANT: Please read before installation

- Always turn off power prior to installation or replacement.
- Continuous Tape Light contacts are very fragile, handle with care.
- Do not turn on Tape Light while on the spool, may cause the tape light to overheat and melt or ignite.
- Do not press directly on the LEDs themselves, as it may cause damage.
- Do not use the product in a potentially combustible environments.
- Do not cover this product as the covering may cause the tape light to overheat and melt or ignite.
- Do not operate with the tape light tightly coiled.
- Do not route the cord or tape light through walls, doors, windows or any like part of the building structure.
- Do not use if there is any damage to the light or cord insulation. Inspect periodically.
- Continuous Tape Series is cULus Listed for Damp Location.
- Secure the tape light using only the 3M™ tape, hangers, clips, or NATHR-680 Aluminum Channel (sold separately). Do not secure this product or its cord with staples, nails, or like means that may damage the insulation or permanently attach to the building structure.
- Wire leads and accessories are not rated for in-wall installation unless otherwise noted.
- Attached wire leads and connections are field-cuttable.
- Tape light, attached wire leads, and additional extension cables, connectors, etc., are not rated for in-wall installation unless otherwise noted.
- Do not install in environment where LED chips are exposed to direct sunlight as damage to the phosphor will occur.
- Do not install in environment where excessive heat may exist (ex. close proximity to the fireplace, etc.)
- See operating temperature on spec sheet.

INSTALLATION INSTRUCTIONS:

1. Decide where you want to place the LED tape light.
2. The tape light has a 3M™ self-adhesive backing, ensure the surface area that you intend to adhere the tape light to is clean and dry. Simply remove the backing strip and carefully lay the tape light in place working from one end to the other ensuring there are no raised sections.
3. Using a lint-free cloth gently press between the LEDs on the tape to remove any air bubbles and activate the adhesive, make sure you do not press on the LEDs themselves as this could damage the joint.

WIRING INSTRUCTIONS TO DRIVER:

1. Only use with Class 2 24V power supply.
2. Driver may have a male plug and the LED Tape Light may have a the female connector. Plug male connector into female connector together. Some drivers will require connecting + and - wire together.

POLARITY: Continuous Tape has + and - markings. These must be connected to + and - of the driver leads or another tape lead.

Installation Instructions

NUTP51 / NUTP81 / NUTP71

Continuous Tape

READ PRIOR TO ATTEMPTING INSTALLATION
 ALWAYS TURN OFF MAIN POWER BEFORE INSTALLATION
 INSTALLATION SHOULD BE CARRIED OUT BY YOUR LOCAL ELECTRICIAN

CUTTING INSTRUCTIONS - SEE BACK SIDE FOR JOINING INSTRUCTIONS:

1. The LED tape light may be cut every 4".
2. Carefully cut the tape light along the line, be careful not to press on the LEDs as this could damage the joint.

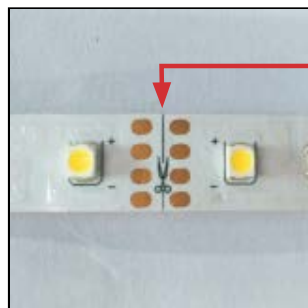
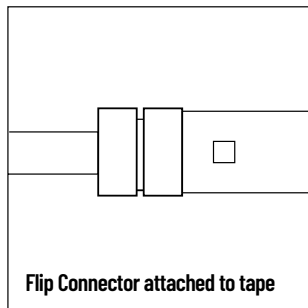
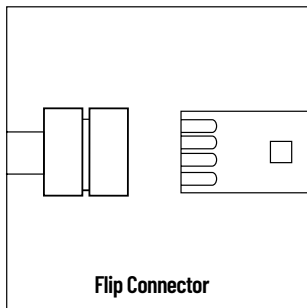

MAY BE CUT AT THE CUT LINE.

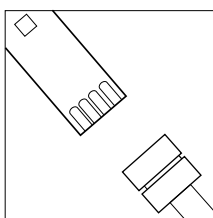

EXTENSION CONNECTOR INSTALLATION INSTRUCTIONS TO ENSURE ETL OR CULUS LISTING:

1. Have one male and one female end of the tape light.
2. Insert male or female end of tape light into one end of the extension connector.
3. Snap the connector cover close on both end.

DO NOT PUT TAPE ABOVE METAL CONNECTORS!

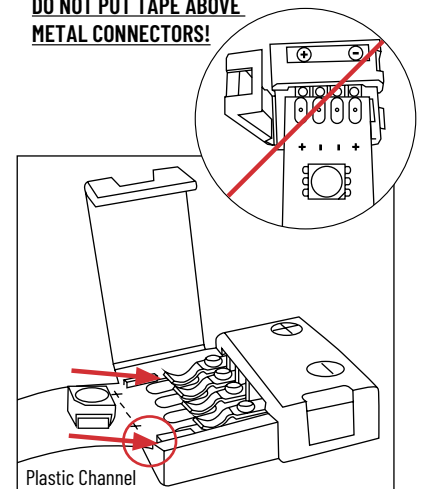

LIST OF DRIVER'S THAT CAN BE USED WITH CONTINUOUS 24V TAPE:

- NATL-524: 24 watt Plug-In
- NATL-545: 45 Watt Plug-In
- NATL-596: 96 Watt Plug-In
- NATL-5060HW: 60 Watt Hard Wire
- NATL-5100HW: 100 Watt Hard Wire
- NATL-530HW: 30 Watt Hard Wire or Plug-in
- NATL-560HW: 60 Watt Hard Wire or Plug-in
- NMTD-60/24D: 60 Watt Dimmable Magnetic Hard Wire
- NMTD-96/24D: 96 Watt Dimmable Magnetic Hard Wire
- NMT-303/24C2D1: 3x100 Watt Dimmable Magnetic Hard Wire
- NATL-SWEX100/24: 100 Watt Dimmable Electronic with Dimmer for single gang box



Slide the tape **INTO** the plastic channels and **UNDER** the metal connectors.



WARNING!

DO NOT CONNECT DIRECTLY TO HIGH VOLTAGE POWER!

Read all warnings and installation instructions thoroughly.

HANDLE LED TAPE LIGHT WITH CARE!



DO NOT BEND LED STRIP LIGHT TO A DIAMETER LESS THAN 1.5 INCHES.

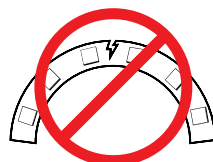

DO NOT BEND LED STRIP LIGHT ON A HORIZONTAL PLANE

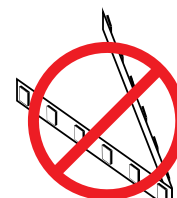

DO NOT FOLD, CREASE, OR TWIST LED STRIP LIGHT.

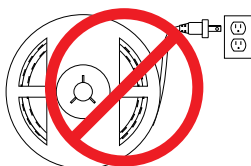

DO NOT POWER STRIP LIGHT WHILE ATTACHED TO SPOOL OR TIGHTLY COILED.



DO NOT PUT EXCESSIVE PRESSURE ON SURFACE OF TAPE LIGHT (GLASS/ACRYLIC PLANES ETC.)

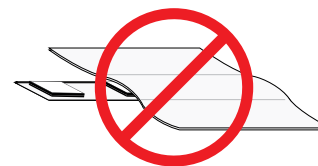

DO NOT COVER STRIP LIGHT WITH ANY MATERIALS.

Installation Instructions

NUTP51 / NUTP81 / NUTP71

Continuous Tape

READ PRIOR TO ATTEMPTING INSTALLATION
ALWAYS TURN OFF MAIN POWER BEFORE INSTALLATION
INSTALLATION SHOULD BE CARRIED OUT BY YOUR LOCAL ELECTRICIAN



When sliding the ribbon into the flip connector, make sure to fully insert the ribbon under the side tabs and UNDER the metal contact. Make sure the polarity is correct.

Step 1



Open the snap cover.

Step 2

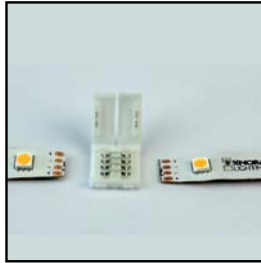

Take a ribbon and align it to the snap cover.

Step 3

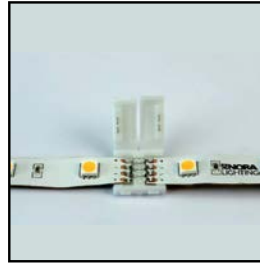

Assign polarities and slide the ribbon into the connector.

Step 4



Seat the ribbon in fully and close the snap cover.

NATLCFC-200 & 600 SERIES INTERCONNECTORS

Step 1



Open the snap cover.

Step 2



Take a ribbon and align it to the snap cover.

Step 3

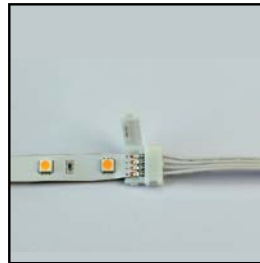

Assign polarities and slide the ribbon into the connector.

Step 4



Seat the ribbon in fully and close the snap cover.

NATLCFC-208 & 608 SPLICE CONNECTORS

Step 1



Open the snap cover.

Step 2

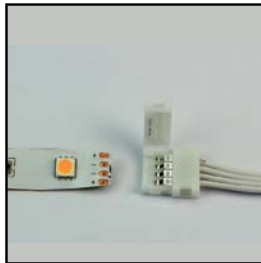

Take a ribbon and align it to the snap cover.

Step 3

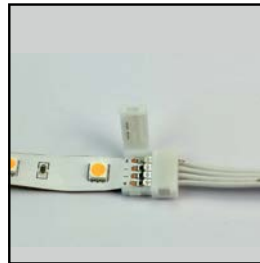

Assign polarities and slide the ribbon into the connector.

Step 4



Seat the ribbon in fully and close the snap cover.

NATLCFC-209 & 609 PLUG CONNECTOR

Step 1



Open the snap cover.

Step 2

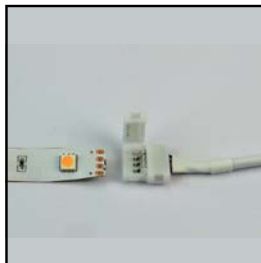

Take a ribbon and align it to the snap cover.

Step 3

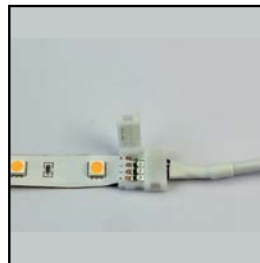

Assign polarities and slide the ribbon into the connector.

Step 4



Seat the ribbon in fully and close the snap cover.