

Installation Instructions

URGENT: READ PRIOR TO ATTEMPTING INSTALLATION

TRANSFORMER & DRIVERS - CLASS II DIMMABLE HARDWIRE LED DRIVER

ALWAYS TURN OFF MAIN POWER BEFORE INSTALLATION

Item#	Description	Rating
NMTD-60/12D	12V 60W Class II Hardwired Dimmable Driver	12V / 60W
NMTD-60/24D	24V 60W Class II Hardwired Dimmable Driver	24V / 60W
NMTD-40/12D	12V 40W Class II Hardwired Dimmable Driver	12V / 40W
NMTD-96/24D	24V 96W Class II Hardwired Dimmable Driver	24V / 96W

INSTALLATION SHOULD BE CARRIED OUT BY YOUR LOCAL ELECTRICIAN.

PLEASE READ: IMPORTANT INFORMATION BEFORE INSTALLATION

NMTD series is for indoor use only. Must be installed in a well-ventilated area free from explosive gases and vapors. Proper operation requires the free flow of air. As this transformer is hard-wired, it should only be installed by a qualified electrician.

Installation:

- Shut off power at the main breaker before attempting installation
- This power unit may be installed with a compatible 120V magnetic low voltage dimmer switch
- Compatible 3-way 120V MLV dimmers
- All direct wire connections to the Dimmable Driver must be secured inside the built-in junction box
- A disconnect device shall be incorporated in the field wiring.
- Risk of electric shock. Do not use any connection pins to touch any electrical conductors.
- This equipment is intended to be installed only by qualified personnel. The installation must be made in accordance with the current edition to the National Electrical Code and all applicable state and local building codes. The final installation must be approved by the appropriate qualified electrical/building inspector. Improper installation may result in a fire or electrical hazard. Be sure the electrical power to the circuit has been disconnected before installing this electrical system.

Mounting

- Locations for mounting must be able to support the weight of the Power units.
- It is recommended to mount the Power units vertically with the wiring compartment pointed downward.
- N.E.C. requires all Power units to be grounded to the GREEN groundign wire, use 18AWG

Knockouts

- Remove wiring knockouts as needed and install 1/2" Strain relief to reduce strain on wires.
- One knockout is reserved for input voltage while the second knockout is reserved for output voltage.

Connection

- Refer to the wiring diagram provided for accurate wire connections.
- The Red (+) wire is the Positive lead wire. The Black (-) wire is the negative lead wire.

NMTD-60/12D

120V TAP CONNECTION

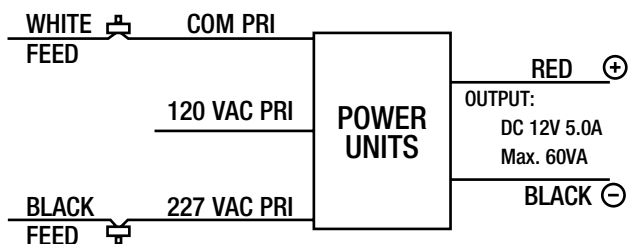

277V TAP CONNECTION

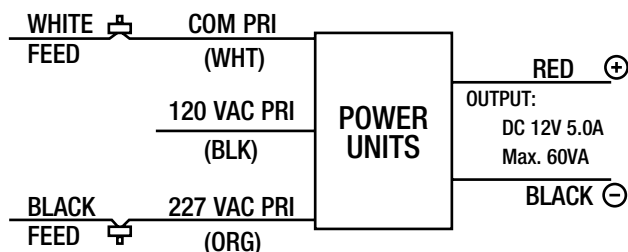

Installation Instructions

URGENT: READ PRIOR TO ATTEMPTING INSTALLATION

TRANSFORMER & DRIVERS - CLASS II DIMMABLE HARDWIRE LED DRIVER

ALWAYS TURN OFF MAIN POWER BEFORE INSTALLATION

NMTD-40/12D

120V TAP CONNECTION

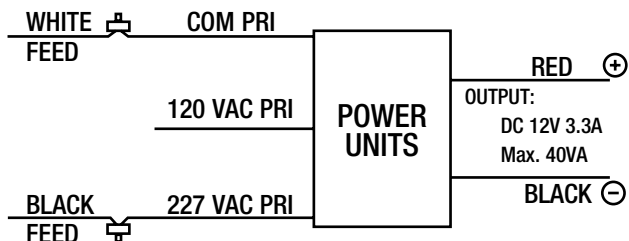

277V TAP CONNECTION

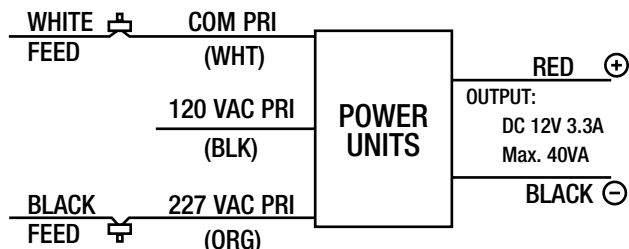

NMTD-60/24D

120V TAP CONNECTION

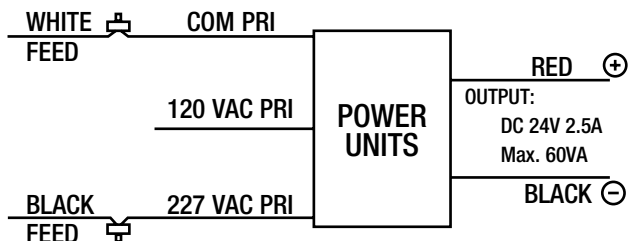

277V TAP CONNECTION

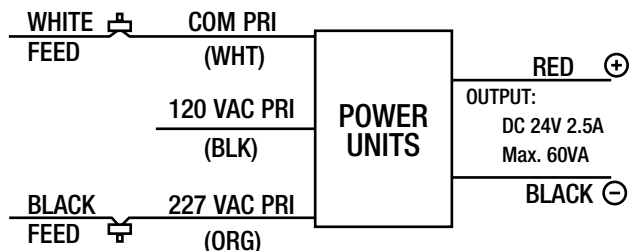

NMTD-96/24D

120V TAP CONNECTION

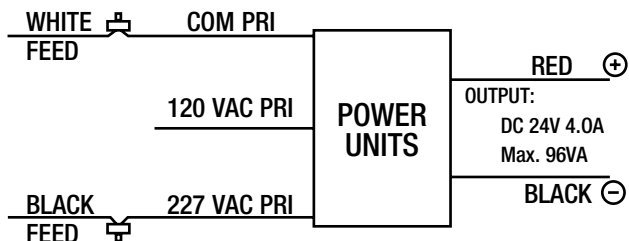

277V TAP CONNECTION

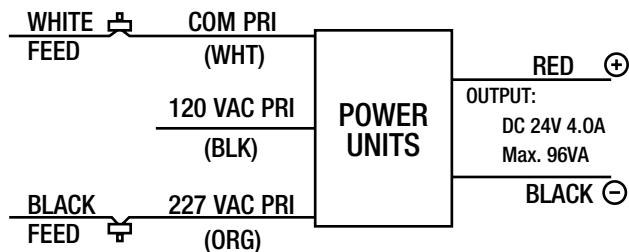

Characteristics

- Constant voltage
- Overload protection
- Thermal protection

Red light on when overloaded

Attention: Press restore button after loading back to normal

Installation Instructions

URGENT: READ PRIOR TO ATTEMPTING INSTALLATION

TRANSFORMER & DRIVERS - CLASS II DIMMABLE HARDWIRE LED DRIVER

ALWAYS TURN OFF MAIN POWER BEFORE INSTALLATION

INSTALLATION SHOULD BE CARRIED OUT BY YOUR LOCAL ELECTRICIAN.

Item#	Description	Rating
NMTD-60/12D	12V 60W Class II Hardwired Dimmable Driver	12V / 60W
NMTD-60/24D	24V 60W Class II Hardwired Dimmable Driver	24V / 60W
NMTD-40/12D	12V 40W Class II Hardwired Dimmable Driver	12V / 40W
NMTD-96/24D	24V 96W Class II Hardwired Dimmable Driver	24V / 96W

INCLUDED IN BOX:

QTY.	DESCRIPTION
1	40W/60W/96W Transformer
1	10' Power Line Connector
1	Strain Relief
2	1/2" Caps

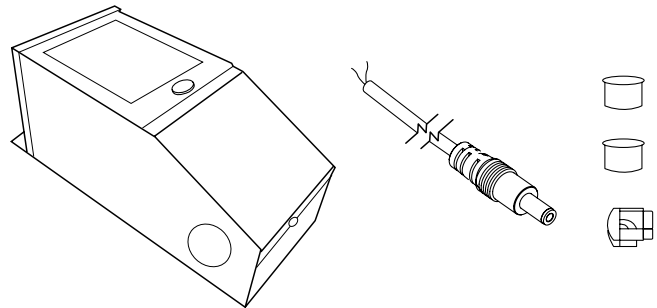

Installation Instruction

- Insert flat head screwdriver. Lift up transformer cover towards you (Dia.1)
- Determine which side you are going to feed the transformer through 1/2" holes (Dia.1)
- Feed and wire 10' power line connector through 1/2" hole (Dia.2)
- Apply strain relief to cable and insert into 1/2" hole (Dia.3)
- Refer to the wiring diagram provided on page 1 for accurate wire connections.
- Place cap over unused 1/2" hole
- Replace transformer cover

