

NC2-439

4" Adjustable Sapphire II High Lumen Reflector

Source: 16W to 24W LED
900lm to 1500lm

Type
Project
Catalog No.
Notes

PRODUCT DESCRIPTION

Adjustable Sapphire II COB Series is a commercial grade LED high lumen downlight. The Sapphire II uses the latest COB technology by Cree®, which allows for better optic control offering three beam spreads. Beam spreads focus the light down to the work plane from high ceiling applications. The reflectors have been designed for the high efficiency (LPW) while providing low aperture brightness. The Sapphire II COB Series is proudly assembled in the USA.

FEATURES

- Adjustable mechanism tilts up to 30° vertically and 359° horizontal rotation
- Locking vertical aiming
- Adjustable from below the ceiling
- Cree® COB technology
- Shatter resistant lens
- Specifiable beam spreads
- 900lm or 1500lm LED packages
- 2700K, 3000K, 3500K and 4000K @ 90+ CRI
- 5-year limited warranty
- ENERGY STAR certified

ELECTRICAL

Lumens / Wattage: L09 = 900lm / 16W; L15 = 1500lm / 24W

Color Temperature: 2700K, 3000K, 3500K, 4000K

CRI: 90+CRI

Beam Spread: (S) 36° Spot; (M) 50° Narrow Flood; (F) 70° Flood

Lifetime: 50,000 hours @ L70

COMPATIBLE HOUSING

Reflector is only compatible with respective housings manufactured by Nora Lighting.

CATALOG NO. DESCRIPTION

NCAH2-439 4" New Construction Housing for Sapphire Adjustable

SPECIFICATION

Reflector: Bias cut reflector spun from 0.050 high grade aluminum allows LED light engine to illuminate along axis.

Reflector Assembly: The reflector assembly includes the LED optical package and heat sink mounted on top. Reflector assembly easily wires to dedicated housing with lockable quick connect. Reflector assembly has graduation marks and locking screw.

LABELS AND LISTINGS

- cULus Listed for Damp Locations
- ENERGY STAR certified
- [5-Year Limited Warranty](#)
- FCC compliant



PRODUCT IMAGE & DIMENSIONS

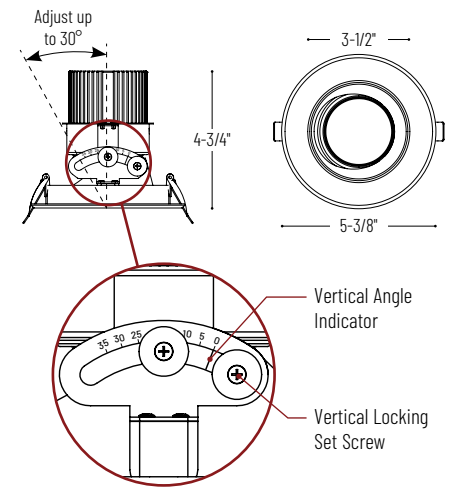

BSF Black Reflector / Self Flanged **HSF** Haze Reflector / Self Flanged



HWSF Haze Reflector / White Flange **WSF** White Reflector / Self Flanged

4" Adjustable Sapphire II Reflector - Dedicated Housing Required

Reflector Type	Lumens / Wattage	Color Temperature / CRI	Beam Spread	Reflector / Flange Finish
NC2-439 = Adjustable Reflector	L09 = 900lm / 16W	27 = 2700K / 90 CRI	S = 36° Spot	BSF = Black Reflector / Self Flanged
	L15 = 1500lm / 24W	30 = 3000K / 90 CRI	M = 50° Narrow Flood	HSF = Haze Reflector / Self Flanged
		35 = 3500K / 90 CRI	F = 70° Flood	HWSF = Haze Reflector / White Flange
		40 = 4000K / 90 CRI		WSF = White Reflector / Self Flanged

Example: **NC2-439L1530WSF** = 4" Adjustable Sapphire II Reflector, 1500lm / 24W LED, 3000K, 36° Spot Beam Spread, White Reflector / Self Flanged

NCAH2-439

4" Adjustable Sapphire II Non-IC New Construction Housing

Source: 16W to 24W LED

900lm to 1500lm

Type _____

Project _____

Catalog No. _____

Notes _____

PRODUCT DESCRIPTION

Adjustable Sapphire II COB Series is a commercial grade LED high lumen downlight. The Sapphire II uses the latest COB technology by Cree®, which allows for better optic control offering three beam spreads. Beam spreads focus the light down to the work plane from high ceiling applications. The Sapphire II series is available in 4", 6" or 8" apertures.

CONSTRUCTION

Plaster Frame: 0.040" galvanized steel frame with integral bar hanger brackets. Brackets can accommodate longer 27" accessory flat bar hangers. Brackets run along all sides of frame to allow bar hangers to be run parallel or perpendicular to junction box.

Housing: 0.040" aluminum housing adjusts for ceiling thicknesses from 1/2" to 1-1/4".

Minimum Clearances: Non-Insulated housings require a minimum clearance of 3" from thermal insulation and 1/2" from adjacent building components. Housings require 24" between adjacent recessed luminaires on center.

Junction Box: Plaster frame integrated 29 cubic inch 0.064" thick galvanized steel, with seven 1/2" knockouts, four pryouts, and snap on cover. Electrical connections are made through a single junction box door. Green wire provided for installations with ground wire fed through PVC pipe conduit. Junction box connects to reflector assembly with lockable quick connect.

ELECTRICAL

Input Voltage: 120-277V

Lumens / Wattage: L09 = 900lm / 16W; L15 = 1500lm / 24W

Operating Temp.: 0°C to 45°C ambient temperature

Dimming: Triac, ELV or 0-10V, must specify

[Click Here](#) or check complete dimmer list at www.NoraLighting.com in the "Compatibility" page under "Resources" tab

COMPATIBLE REFLECTOR

CATALOG NO.	DESCRIPTION
NC2-439	4" Adjustable Reflector

Emergency: Housing can be connected to remote emergency battery, requires top access. Must specify battery with remote test switch separately (NEPK-07LEDUNV).

LABELS AND LISTINGS

- cULus Listed for Damp Locations
- [5-Year Limited Warranty](#)



PRODUCT IMAGES AND DIMENSIONS

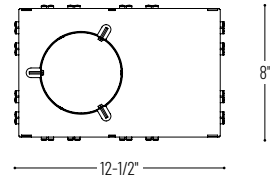
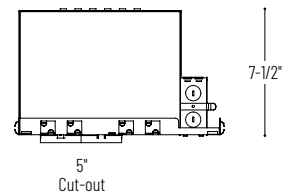
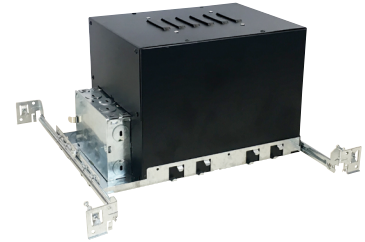

4" Sapphire II New Construction Housing - Compatible with Sapphire II Adjustable Reflector

Housing Type	Lumens / Wattage	Driver
NCAH2-439/ - New Construction	09 = 900lm / 16W	LE6 = 120-277V Input; 0-10V dimming
	15 = 1500lm / 24W	LE3 = 120V Input; Triac, ELV and 0-10V dimming

Optional Emergency

Description
NEPK-07LEDUNV = Remote Emergency Battery w/Test Switch

Example: NCAH2-439/15LE6 = 4" Sapphire II New Construction Housing, 1500lm / 24W, 120-277V Input; 0-10V dimming

PHOTOMETRICS

4" Adjustable Sapphire II Series

Type

Project

Catalog No.

Notes

Test Information

Test Number: NTR11407
 Part Number: NC2-439L1530SHWSF
 Beam Spread: 36° Spot
 Lumens: 1609lm
 Wattage: 22.2W
 Efficacy: 72lpw
 CCT / CRI: 3000K / 90 CRI
 Spacing Criteria (0°-180°): 0.58
 Spacing Criteria (90°-270°): 0.58

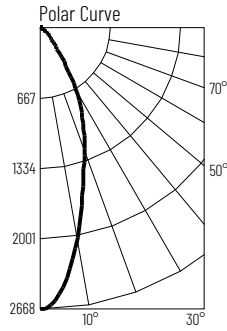

Illuminance at a Distance

Distance from Luminaire	FC at Nadir	Beam Diameter
4'	167fc	2'-7"
6'	74.1fc	3'-11"
8'	41.7fc	5'-2"
10'	26.7fc	6'-6"
12'	18.5fc	7'-10"

Zonal Lumen Summary

Zone	Lumens	% Luminaire
0-30	1081	67.2
0-40	1331	82.7
0-60	1516	94.2
0-90	1577	98
90-180	32	2
0-180	1609	100

Candela Table

Vertical Angles	Candela
0	2668
5	2467
15	1552
25	936
35	387
45	147

Test Information

Test Number: NTR11406
 Part Number: NC2-439L1530MHWSF
 Beam Spread: 50° Narrow Flood
 Lumens: 1610lm
 Wattage: 22.2W
 Efficacy: 73lpw
 CCT / CRI: 3000K / 90 CRI
 Spacing Criteria (0°-180°): 0.76
 Spacing Criteria (90°-270°): 0.76

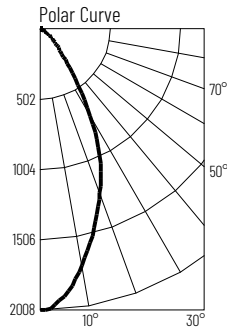

Illuminance at a Distance

Distance from Luminaire	FC at Nadir	Beam Diameter
4'	126fc	3'-8"
6'	55.8fc	5'-7"
8'	31.4fc	7'-5"
10'	20.1fc	9'-4"
12'	13.9fc	11'-1"

Zonal Lumen Summary

Zone	Lumens	% Luminaire
0-30	1038	64.5
0-40	1316	81.7
0-60	1520	94.4
0-90	1579	98.1
90-180	31	1.9
0-180	1610	100

Candela Table

Vertical Angles	Candela
0	2008
5	1918
15	1473
25	995
35	432
45	169

Test Information

Test Number: NTR11404
 Part Number: NC2-439L1530FHWSF
 Beam Spread: 70° Flood
 Lumens: 1338lm
 Wattage: 22.2W
 Efficacy: 60lpw
 CCT / CRI: 3000K / 90 CRI
 Spacing Criteria (0°-180°): 1.02
 Spacing Criteria (90°-270°): 1.02

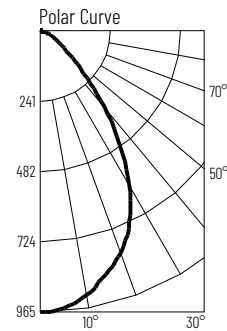

Illuminance at a Distance

Distance from Luminaire	FC at Nadir	Beam Diameter
4'	60.3fc	5'-6"
6'	26.8fc	8'-4"
8'	15.1fc	11'-1"
10'	9.7fc	13'-11"
12'	6.7fc	16'-7"

Zonal Lumen Summary

Zone	Lumens	% Luminaire
0-30	663	49.5
0-40	958	71.5
0-60	1219	91.1
0-90	1308	97.7
90-180	30	2.3
0-180	1339	100

Candela Table

Vertical Angles	Candela
0	965
5	954
15	865
25	723
35	475
45	225