

ASSEMBLY AND INSTALLATION INSTRUCTIONS

T0610

WARNING: Turn off the main power at circuit breaker before installing fixture.
AVERTISSEMENT: Coupez la source d'alimentation principale au panneau central de disjoncteurs avant d'installer le luminaire.

NOTE: 1. Before installing, consult local electrical codes for wiring and grounding requirements.
 2. READ AND SAVE THESE INSTRUCTIONS.

Hardware Package (included):

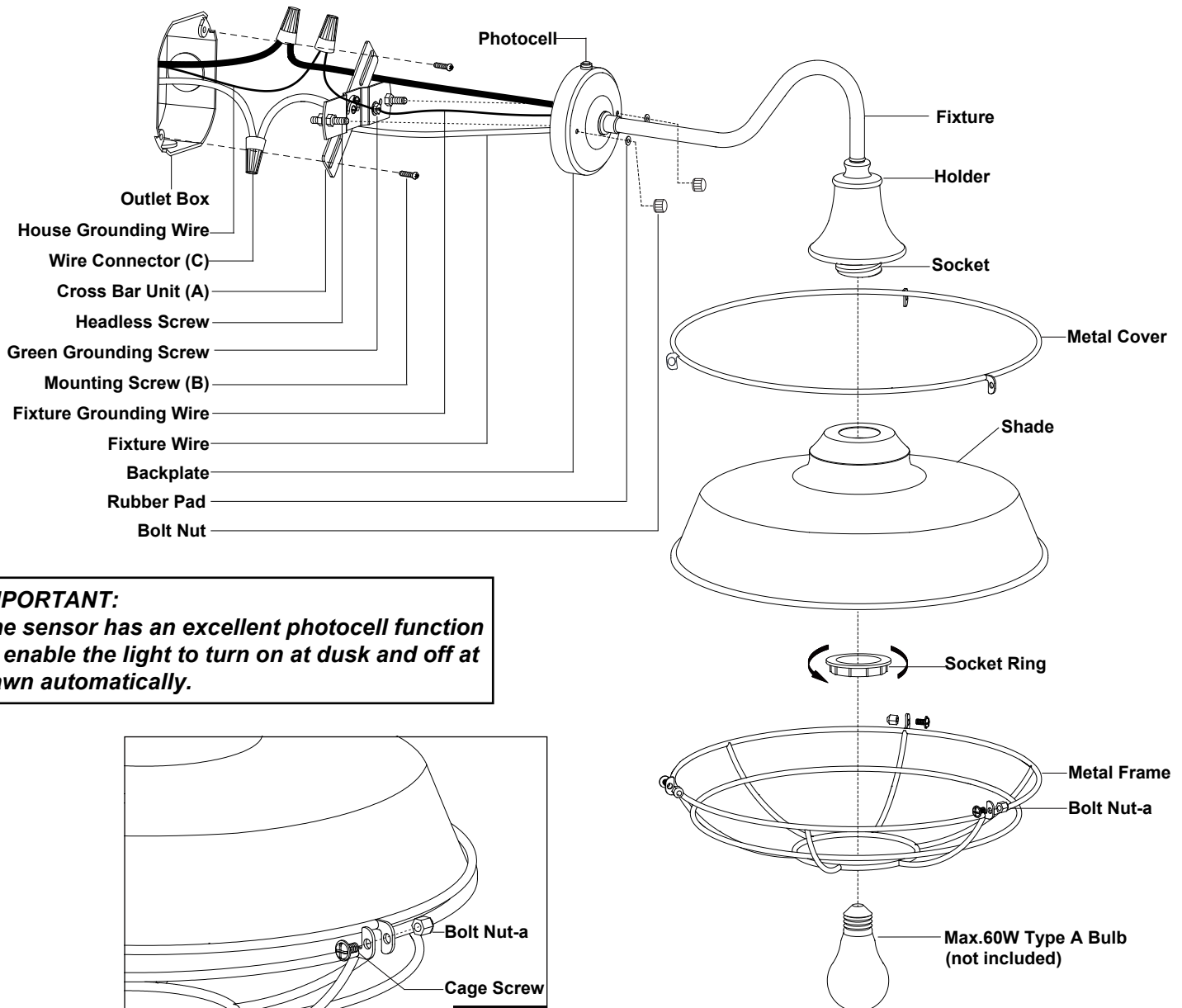
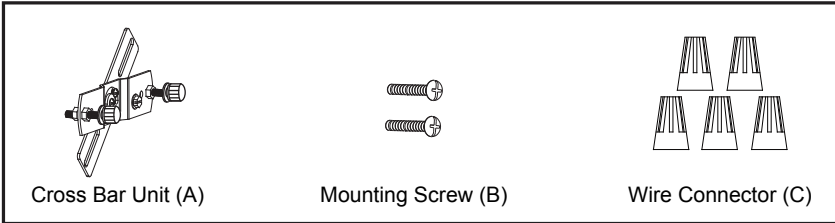

IMPORTANT:

The sensor has an excellent photocell function to enable the light to turn on at dusk and off at dawn automatically.

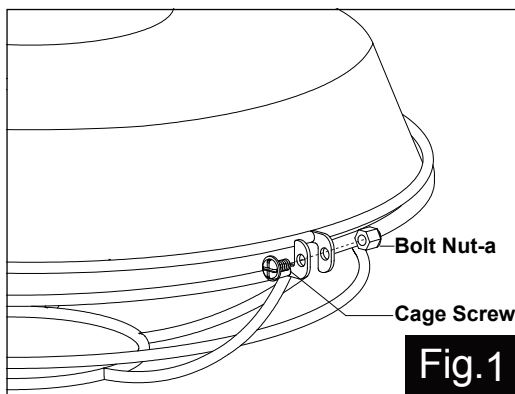

Fig. 1

Installation Steps

Turn off the power at fuse or circuit box.

1. Unscrew the two bolt nuts, remove the two rubber pads and the cross bar unit (A) from the backplate.
2. Attach the cross bar unit (A) to the outlet box by using two mounting screws (B).
3. Pull out the source wires from the outlet box. Make wire connections using wire connectors (C) as follows:
 - Connect the hot wire (usually black insulation) from the fixture to the black wire from the power source.
 - Connect the neutral wire (usually white insulation) from the fixture to the white wire from the power source.
 - Attach the fixture grounding wire (usually green with the insulation or bare wire) to the cross bar unit (A) with the green grounding screw. Then, depending on local code, connect it to the house grounding wire with the wire connector (C).Carefully put all of the wires back into the outlet box.
4. Attach the backplate of the fixture to the cross bar unit (A) by inserting headless screws into set holes on the backplate, then secure it with two rubber pads and two bolt nuts.
Note: With silicone caulking compound, caulk completely around where the backplate meets with the wall surface to prevent water from seeping into the outlet box.
5. Gently place the shade into the metal cover, then attach the metal frame to the metal cover by aligning holes, secure it with the three cage screws and bolt nuts-a from the holes of the metal frame into the holes of the metal cover.
6. Attach the shade to the socket, then secure it with the socket ring.
7. Install a bulb (not included). Check relamping label at socket area or packaging for maximum wattage allowed.

Turn on the power at fuse or circuit box.

Optional Installation: Disconnect Dusk-to-Dawn Photocell

IMPORTANT:

Compatible with dimmer when photocell is disconnected.

* Requires dimmable bulb and compatible dimmer switch.

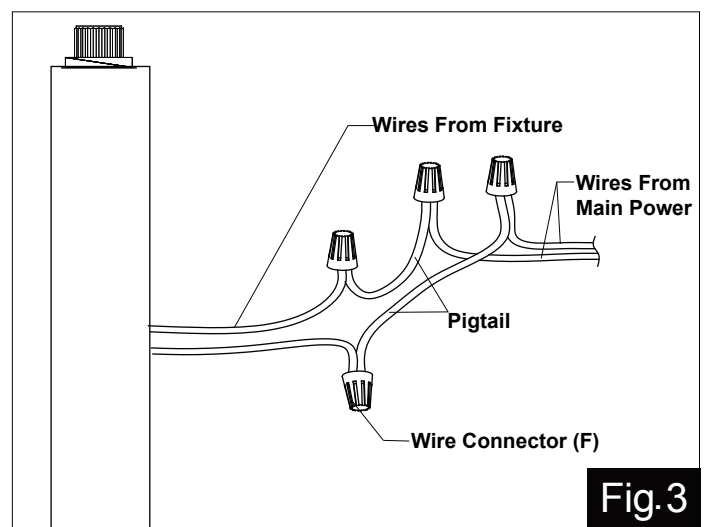
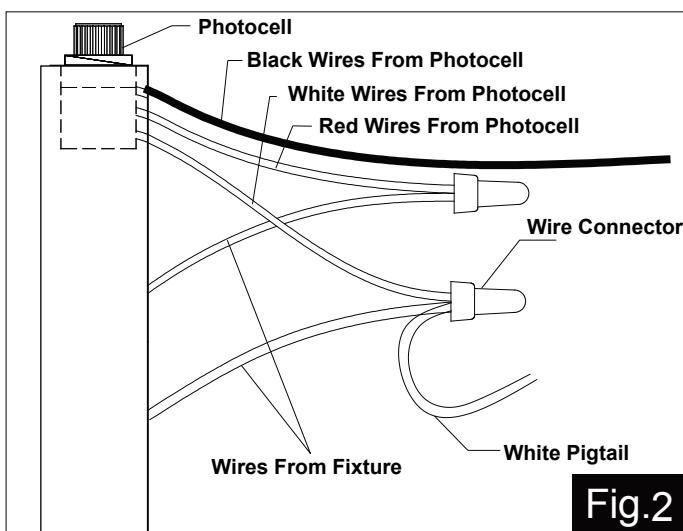







1. Turn off the power at the fuse or circuit box before starting installation.
2. Loosen the wire connectors connected with the wires from photocell. (See Fig.2)
Note: Do not remove the photocell to prevent water from seeping into the outlet box.

3. Take a white pigtail and black pigtail and make wire connections using wire connectors (C): (See Fig.3)
 - a. The black wire from the fixture to one end of the black pigtail.
 - b. The white wire from the fixture to one end of the white pigtail.
 - c. The other end of the black pigtail to the black wire from the power source.
 - d. The other end of the white pigtail to the white wire from the power source.
 Put all wires back into the back plate of the fixture.

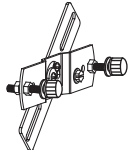
Turn on the power at fuse or circuit box.

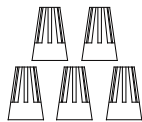
The following parts are available for re-order if damaged or missing.

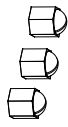
Spare Parts List:

 <p>Cross Bar Unit (A)</p>	 <p>Mounting Screw (B)</p>	 <p>Wire Connector (C)</p>	 <p>Assembly Kit 6433MM (1 SET)</p>
 <p>Cage Screw</p>	 <p>Bolt Nut-a</p>	 <p>Assembly Kit 6434IC (1 SET)</p>	

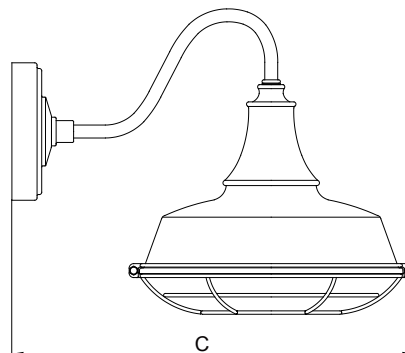
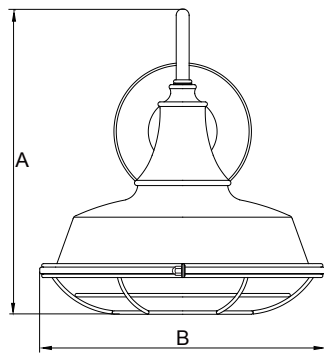

- A: 10-1/4"
- B: 9"
- C: 13-3/4"