

SEMI-FLUSH FIXTURE INSTALLATION INSTRUCTIONS

Please read carefully and save these instructions, as you may need them at a later date.

CAUTION

WARNING: Risk of Fire. Consult a qualified electrician to ensure correct branch circuit conductor. Min 90°C supply conductors.

Turn off the main power at the circuit breaker before installing the fixture, in order to prevent possible shock.

GENERAL

All electrical connections must be in accordance with local and National Electrical Code (N.E.C.) standards. If you are unfamiliar with proper electrical wiring connections obtain the services of a qualified electrician.

Remove the fixture and the mounting package from the box and make sure that no parts are missing by referencing the illustrations on the installation instructions.

ASSEMBLY AND INSTALLATION

1. Thread the cylinder nut screw (10) with hex nut (8) to mounting bar (6).
2. Secure the mounting bar (6) with mounting screw (7) to the outlet box (1).
3. Pull out the outlet wire and ground wire from the outlet box (1). Make wire connections
 - Ribbed wire (w/o marking) from light to white wire (2) from power source.
 - Smooth wire (w/o marking) from light to black wire (3) from power source.
 - Loop the ground wire (4) to mounting bar (6) with a ground wire screw (9)
4. Attach the fixture canopy (11) against the outlet box (1), secure with the Cylinder nut (12)
5. Install bulb (14): (bulb not included)
6. Hang shade (15) over the sockets on fixture canopy (11) secure with three hand screws (13) on the cover.
(Please don't exceed the maximum capacity that recommended on the sockets).

INSTALLATION IS NOW COMPLETED

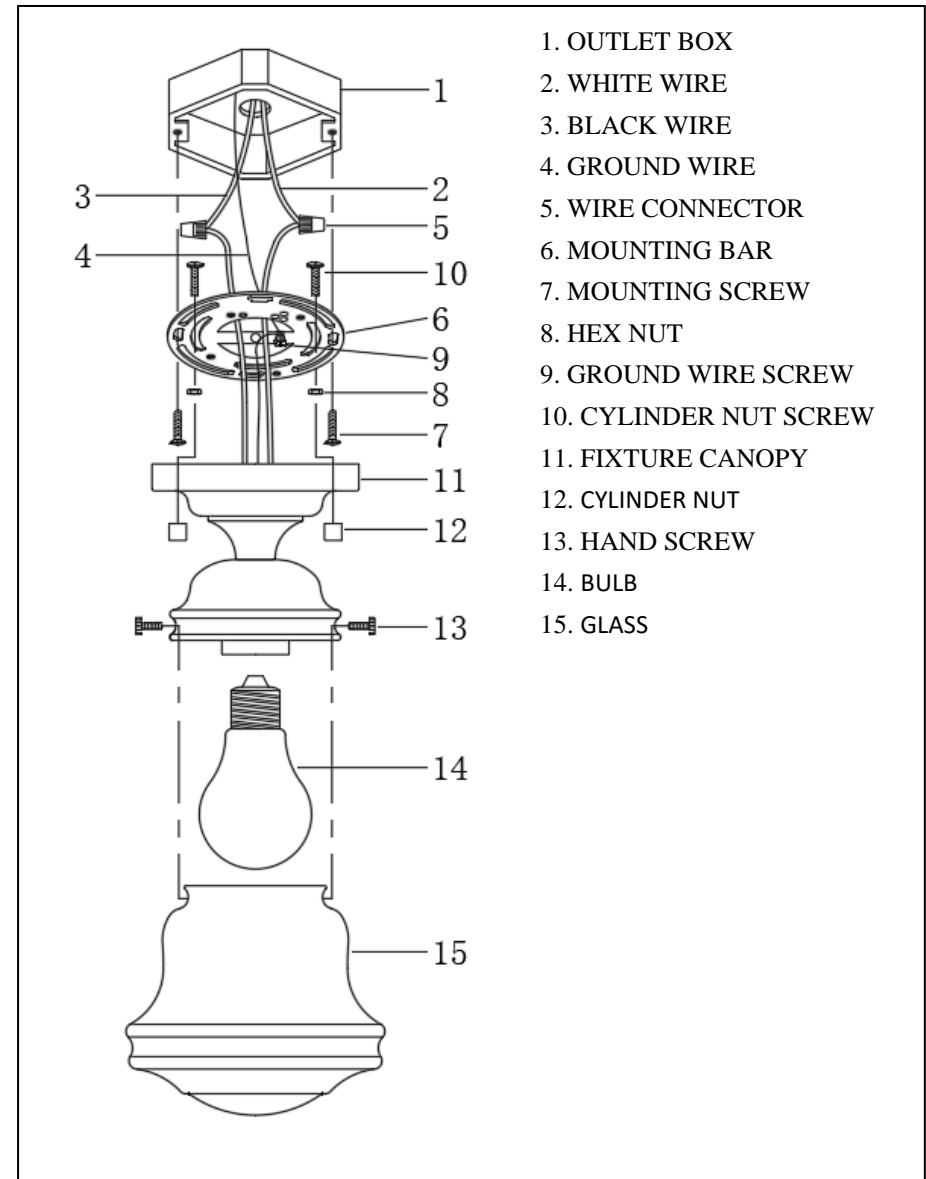

**Line art shown may not exactly match the fixture enclosed.
However, the installations do apply to this fixture.**

ITEM NO: 735F1 736F1